

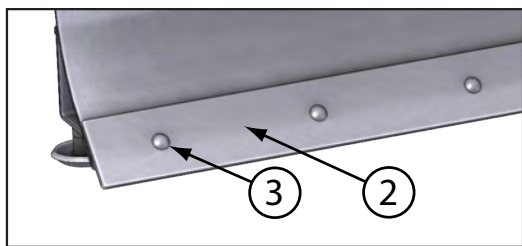

**60" PRO-S SERIES
PLOW BLADE
Model# 105060
Installation Manual**





BLADE IS REVERSIBLE

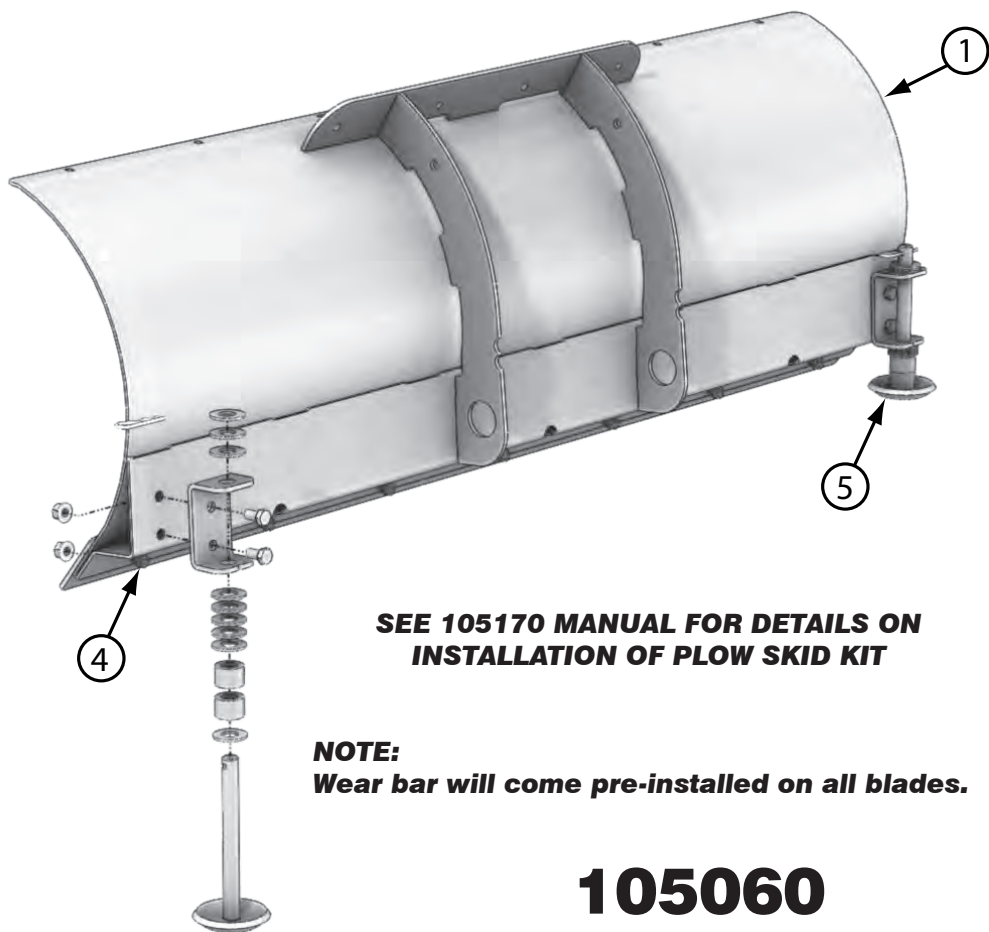

**SEE 105170 MANUAL FOR DETAILS ON
INSTALLATION OF PLOW SKID KIT**

NOTE:
Wear bar will come pre-installed on all blades.

105060 PARTS LIST

REVISION B

ITEM	PART#	DESCRIPTION	QTY.
1	105063	KFI 60" STRAIGHT BLADE	1
2	105064	KFI 60" WEAR BAR	1
3	CB-8Z-031-18-100	5/16"-18 X 1.00" CARRIAGE BOLT GR8 ZINC	7
4	HNFN-5Z-031-18-100	5/16"-18 HEX NUT FLANGE NYLOCK GR5 ZINC	7
5	105170	SKID KIT	1



2 Year Limited Warranty

Kappers Fabricating, Inc. (KFI) warrants to the original purchaser that the product is free from defects in materials and workmanship for a period of two (2) years from the original date of purchase. We will repair or replace, at our discretion, parts found to be defective due to materials or workmanship. This warranty is subject to the following limitations and exclusions:

Commercial Use: The warranty period for any product used for commercial or rental is limited to ninety (90) days from the date of original purchase.

Limitations: This warranty applies only to products which have been properly assembled, adjusted, and operated in accordance with the instructions contained within this manual. This warranty does not apply to any product of Kappers Fabricating, Inc. that has been subject to alteration, misuse, abuse, improper assembly or installation, or shipping damage.

Exclusions: Excluded from this warranty are normal wear, normal adjustments, and normal maintenance.

THIS WARRANTY DOES NOT APPLY TO ANY INCIDENTAL OR CONSEQUENTIAL DAMAGES AND ANY IMPLIED WARRANTIES ARE LIMITED TO THE SAME TIME PERIODS STATED HEREIN FOR ALL EXPRESSED WARRANTIES.

THE WARRANTY SET FORTH ABOVE IS THE ONLY WARRANTY. THERE ARE NO OTHER WARRANTIES, EXPRESS OR IMPLIED, INCLUDING BUT NOT LIMITED TO IMPLIED WARRANTIES OF MERCHANTABILITY OR FITNESS FOR A PARTICULAR PURPOSE.

Some states do not allow the exclusion of implied warranties or the exclusion or limitation of liability for incidental or consequential damages, or limitations on how long an implied warranty lasts, so the above limitation or exclusion may not apply to you. This warranty gives you specific legal rights. You may also have other rights that vary from state to state.

In the event you have a claim under this warranty, contact KFI's Technical Service and KFI will troubleshoot any issue via phone or e-mail. If the problem is not corrected by this method, KFI will, at its option, authorize evaluation, repair or replacement of the defective part or component at a KFI Service Center. KFI will provide you with a case number for warranty service. Please keep it for future reference. Repairs or replacements without prior authorization, or at an unauthorized repair facility, will not be covered by this warranty.

All transportation charges, damage, or loss incurred during transportation of parts submitted for replacement or repair under this warranty shall be borne by the purchaser. Should you have any questions concerning this warranty, please contact us toll-free at 1-877-346-2050. The model number, serial number (If applicable), date of purchase, and the name of the authorized KFI dealer from whom you purchased the product will be needed before any warranty claim can be processed.

For warranty inquiries outside the U.S.A. and Canada, contact your local dealer/distributor.

For countries not covered by a local dealer/distributor, please contact us at www.kfiproducts.com.

Product Registration

Please register your product with Kappers Fabricating, Inc. (KFI) within fifteen (15) days of purchase to assist us in handling any warranty issues that may arise by filling out this Registration card and submitting it with a copy of your sales receipt from one of KFI's official resellers. Failure to complete and return this Registration card does not diminish your warranty rights. Please refer to the above section for complete terms of this warranty.

WARRANTY IS NON-TRANSFERABLE

Please Print Clearly

Fill out and send this section to:
Kappers Fabricating, Inc.
Warranty Registration Department
1015 Industrial Drive, PO Box 32
Spring Valley, MN 55975, U.S.A.

Blade P/N _____

Name _____

Street Address _____

City _____ State _____ Zip Code _____

Phone _____ Email _____

Date of Purchase _____

Authorized KFI Dealer Name _____



Kappers Fabricating, Inc.

**721 Sata Dr.
Spring Valley, MN 55975**

1-877-346-2050

www.kfiproducts.com