

POLARIS GENERAL

PLOW MOUNT

Plow Mount

PART # 106160

Hardware Kit: HK-385

Kit Components:

Item	Qty.	Description
1	1	Frame Bracket
2	1	Plow Mount
3	1	Bolt Plate
4	8	3/8"-16 x 1.00 Hex Flange Bolt
5	2	M12-1.75 x 70 Hex Flange Bolt
6	2	M12-1.75 Hex Flange Nylock Nut

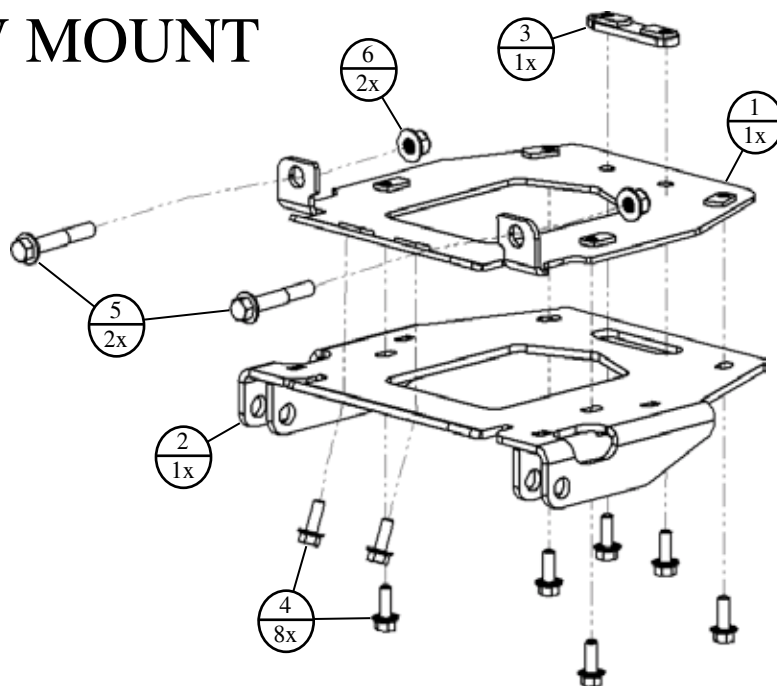

INSTALLATION INSTRUCTIONS:

Make sure all of the hardware needed to complete this mount is in the package. Read through and understand the instructions before installing.

1. Lift the front two tires of the machine off the ground using a floor jack.
2. Remove bolt [A] from the lower front mount of the front A-arm on the passenger side. Replace the stock bolt with the included M12 bolt (5) going in the opposite direction so the threads are facing out towards the front of the machine. Do the same steps to the driver side now shown in [Figure 1](#). **DO NOT REMOVE BOTH A-ARM BOLTS AT THE SAME TIME.**
3. Hold the frame bracket (1) up to the frame lining up the holes with the two M12 bolts (5) sticking out. Loosely attach nuts (6). Shown in [Figures 2 & 3](#).

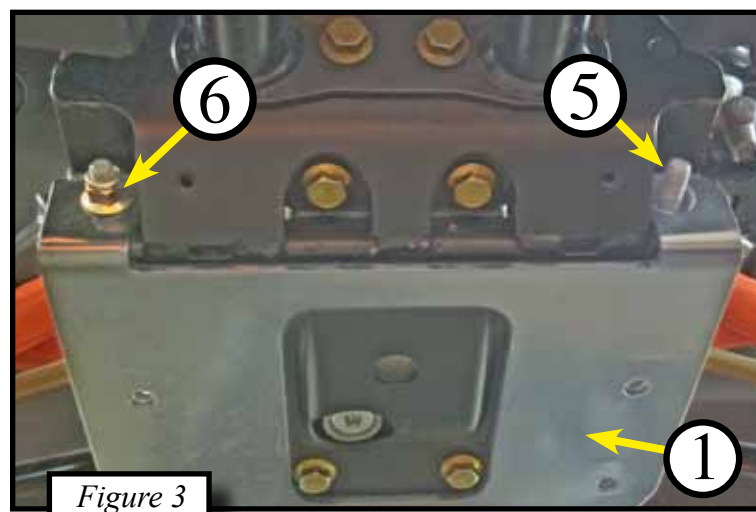
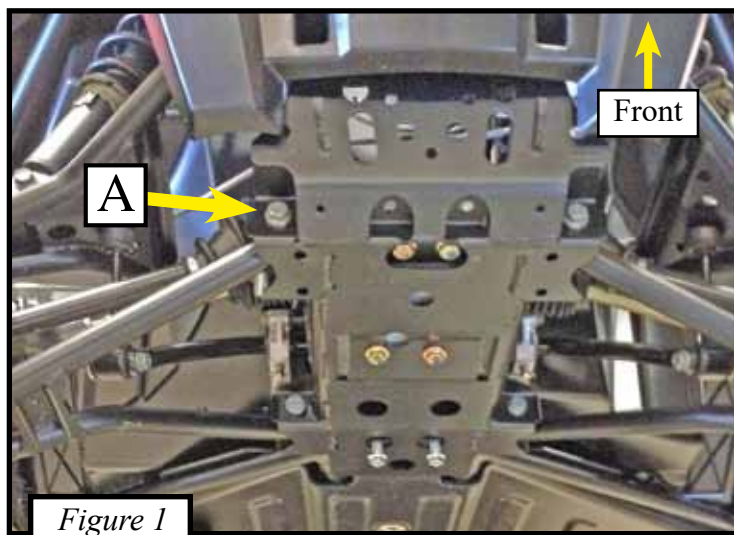
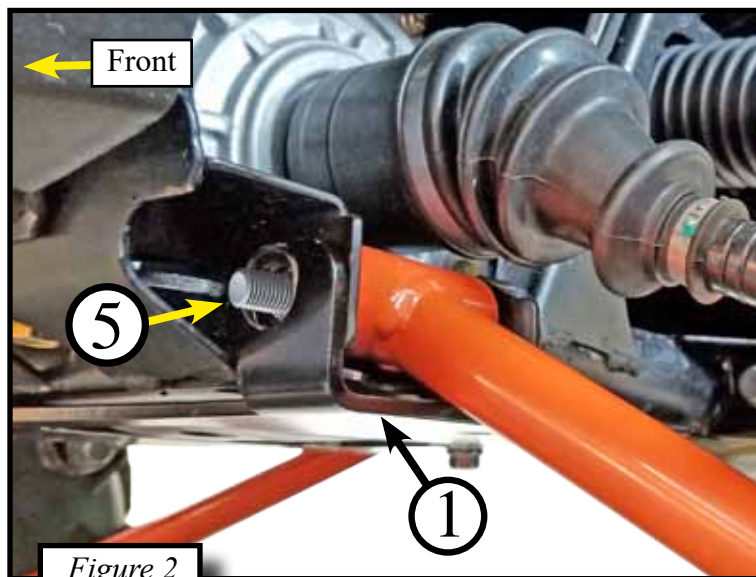

- Place bolt plate (3) over holes in the frame located between the rear mounts of the front a-arms as shown in Figures 4 & 5.

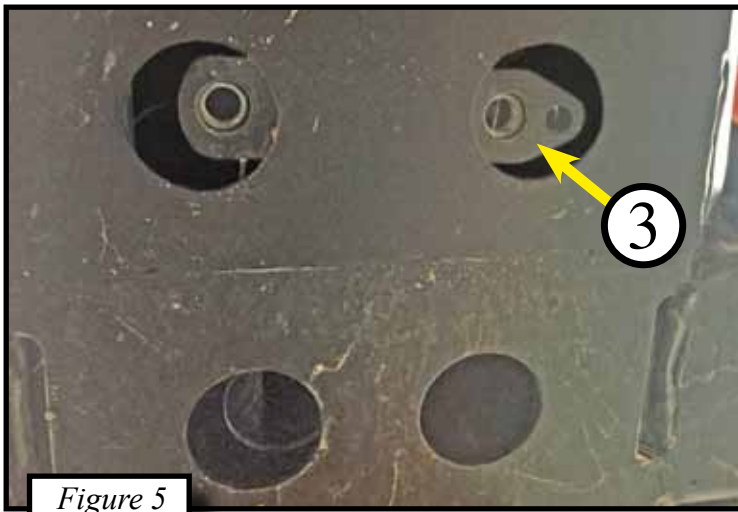
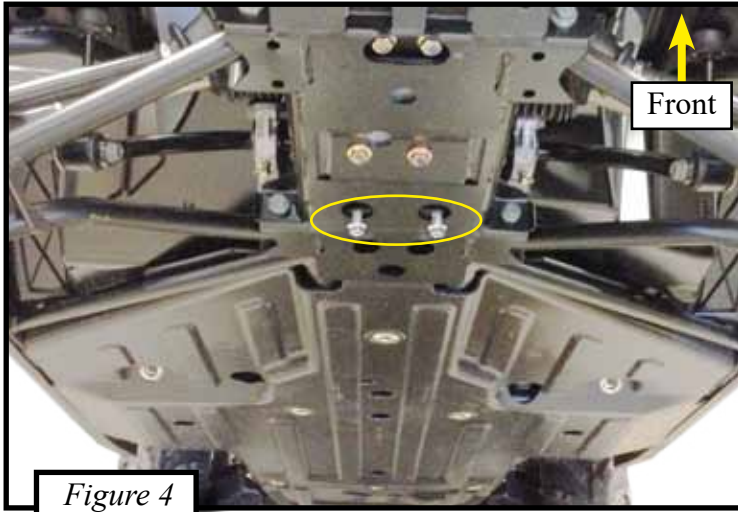

- Hold the rear of the frame bracket (1) to the frame and loosely attach using two bolts (4) into the bolt plate (3). Shown in Figures 5 & 6.

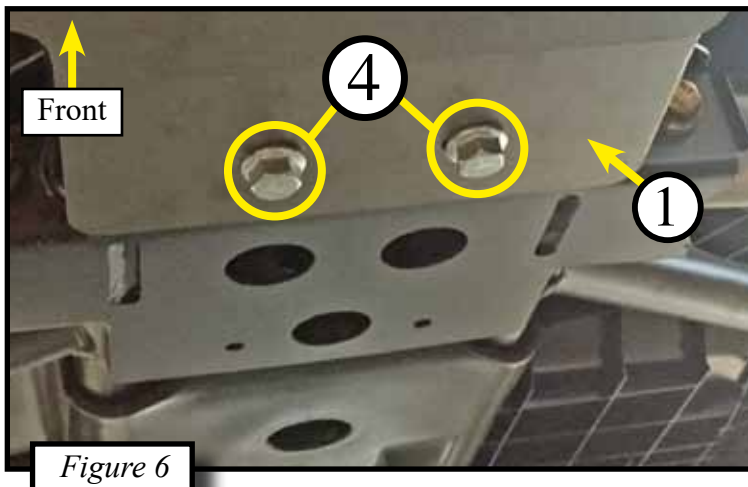

- First evenly tighten the two front A-arm bolts and then tighten up the two rear bolts (4). Shown in Figure 6.
- Attach the plow mount (2) to the frame bracket (1) using the remaining six bolts (4). Tighten bolts evenly. Shown in Figures 7 & 8.
- See UTV Plow Tube System instruction manual for tube attachment.

NOTE: DURING THE OFF SEASON YOU CAN REMOVE PLOW MOUNT (2) FOR MORE CLEARANCE AND LEAVE THE FRAME BRACKET (1) ON THE MACHINE AS DESIGNED.

