

# HIGHLIFTER

780 Professional Drive N. Shreveport, LA 71105 Phone (318)-524-2270 Fax (318)-524-2297

***Thank you for purchasing a High Lifter Lift Kit***



***Please check out our other product lines:***

- ▶ ***Big Lifts***
- ▶ ***Control Arms***
- ▶ ***Trailing Arms***
- ▶ ***Snorkels***
- ▶ ***Radiator Relocation Kits***  
***and many more...***

***Follow Us:***

-  ***@ HighLifterATV***
-  ***@highlifter***
-  ***@HighLifter***
-  ***@highlifterinc***

**HIGHLIFTER**.com

***Need Help? Contact Us***

***Mon-Fri 8am - 5pm CST***

- ▶ ***sales@highlifter.com***
- ▶ ***800-699-0947***

### Read before Installation

This product is designed for use on ATVs and/or RUVs to increase ground clearance and fender clearance. Purchasers should be aware that use of this product may increase the frequency of required maintenance, part wear, and will raise the center of gravity on your ATV and/or RUV, increasing risk of roll-over, injury and death on all types of terrain. It is your responsibility to always inform other operators and passengers of this vehicle about the added risks.

High Lifter Products, products are designed to best fit user's ATV/RUV under stock conditions. Adding, modifying, or fabricating any OEM or aftermarket parts will void warranty. High Lifter Products, products could interfere with other aftermarket accessories. If the user has aftermarket products on machine, contact High Lifter Products to verify that they will work together. Adding aftermarket suspension components and/or more aggressive tires can cause breakage of other OEM driveline components such as differentials, axles or drive shafts.

We recommend that wider tires and/or wheel spacers be used to achieve a wider stance and to improve stability of the ATV and/or RUV. Riders should be advised that the handling characteristics of a taller ATV and/or RUV are different and require extra care when riding, particularly on side hills or off-camber situations. If you further raise the center of gravity by adding taller tires, heavy loads to racks or seats, or by any other means, the ATV and/or RUV must be operated with even more care, at slower speeds and on relatively flat ground. All turns should be done at a slow speed, even on level ground.

Operation of an ATV and/or RUV with or without modified suspension components, while or shortly after consuming alcohol or drugs, subjects the rider to the risk of serious bodily harm or possible death. This risk is compounded if the rider does not wear an approved helmet and other safety gear. High Lifter urges that all approved safety gear be worn when riding an ATV and/or RUV as a driver or passenger.

By purchasing and installing High Lifter Products, products, user agrees that should damages occur, High Lifter Products will not be held responsible for loss of time, use, labor fees, replacement parts, or freight charges. High Lifter Products will not be held responsible for any direct, indirect, incidental, special, or consequential damages that result from any product purchased from High Lifter Products. The total liability of seller to user for all damages, losses, and causes of action, shall not exceed the total purchase price paid for the product that gives rise to the claim.

### Dealers and other Installers

You are responsible for informing your customer and end user of the information contained above and the increased potential hazards of operating an ATV and/or RUV equipped with modified suspension components. If you install any suspension modifying components, it is your responsibility to also install the warning label prominently in view of the driver and in prominent view of the driver and passenger on RUVs and multi-passenger ATVs. They should also be instructed to notify anyone operating the vehicle, as well as any passengers, that said vehicle is modified.

As discussed above, it is critically important that they be instructed in the need for slower speed operation, regardless of terrain, after this lift kit is installed.

# Parts Diagram



**NOTE:** If you have an electric bed lift on your Polaris Ranger, it will require you to slightly modify the lift brackets to achieve proper clearance to allow the bed lift to function properly.

**NOTE:** 1.5" SPACERS ARE REQUIRED IN THE REAR IF YOU ARE RUNNING FACTORY RANGER WHEELS!

**NOTE:** If you are running after market axles in the rear, check for boot clearance against the sway-bar mount on lower rear control arm.

## **FRONT LIFT INSTALLTION**

**(THE FOLLOWING INSTALLTION TAKES PLACE ON THE PASSENGER SIDE)**

- 1) Place UTV transmission in park. Place jack under center of UTV front end and lift until front wheels clear the ground. Be careful to support the UTV properly so that A-arms and shocks can droop to full extension.
- 2) Remove front wheels.
- 3) Disconnect the sway bar from sway bar connecting rods and remove rubber bumpers from both sides of the UTV.

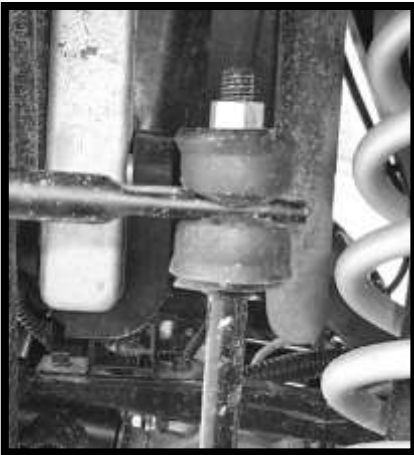

- 4) Disconnect and remove the front shocks.

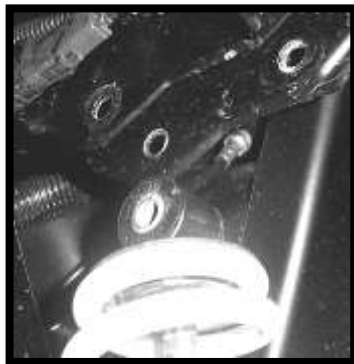

- 5) You will need a spring compressor to install the spring spacers onto the factory shocks in the following steps.

6) Compress the spring and remove the retaining clip and stock spring from the shock.



7) Next place the spring spacer (45Y) onto the shock.



8) Place spring back on the shock, compress it, and then reinstall the retaining clip.

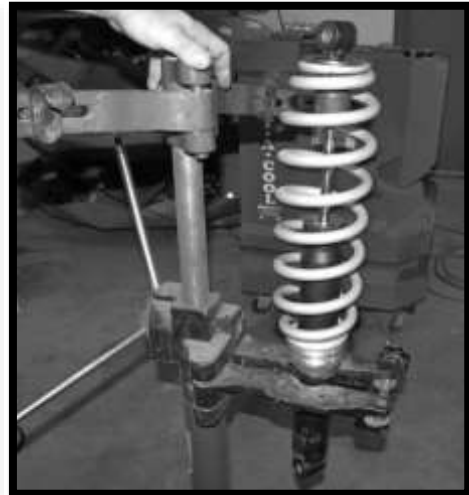

- 9) When installing the front lift bracket make sure to note the direction of the bracket. The slotted hole goes to the inside of the frame and the small ear goes to the top.

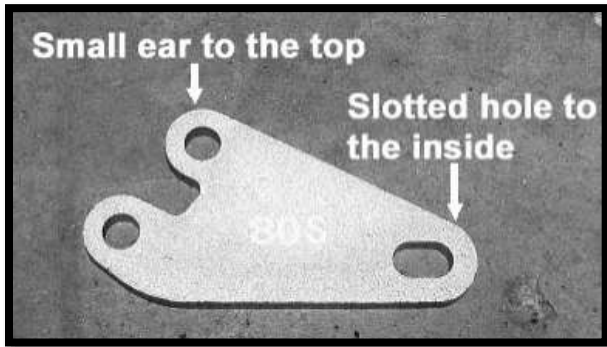

- 10) Place **(1) 80S** lift bracket to the inside of the left frame tab at the lower hole. Insert **(1) 10x65mm hex bolt** through the frame tab and the lift bracket. Then insert **(1) 18T** spacer between the lift bracket and the right frame tab.

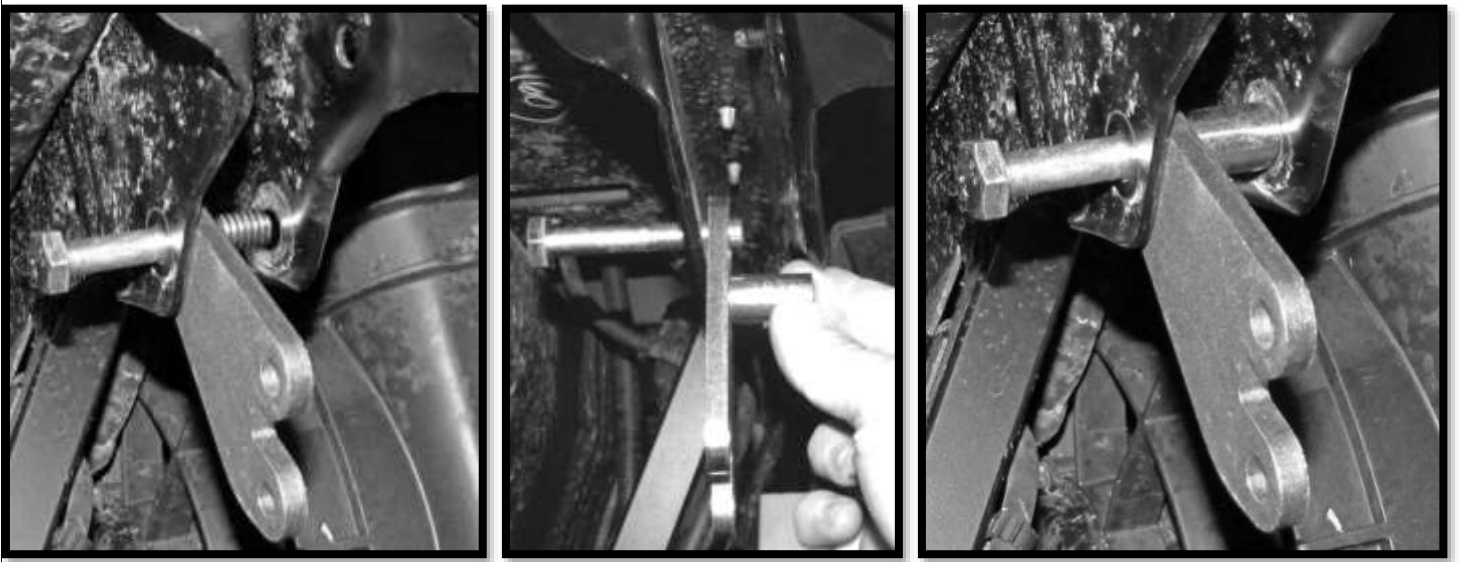

- 11) Insert **(1) 10x65mm hex bolt** through the upper left frame tab hole and the lift bracket. Then insert **(1) 18T** spacer between the lift bracket and the right frame tab.

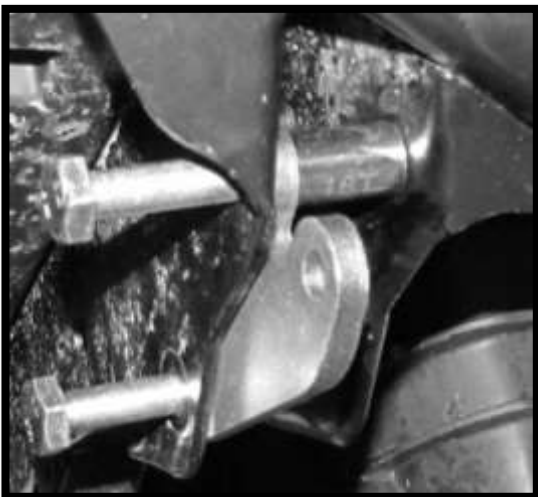

12) Slide **(2) 10mm flat washers** over the end of each bolt. Then slide another 80S lift bracket over the bolts. Loosely fasten each bolt with a **10mm lock nut**.

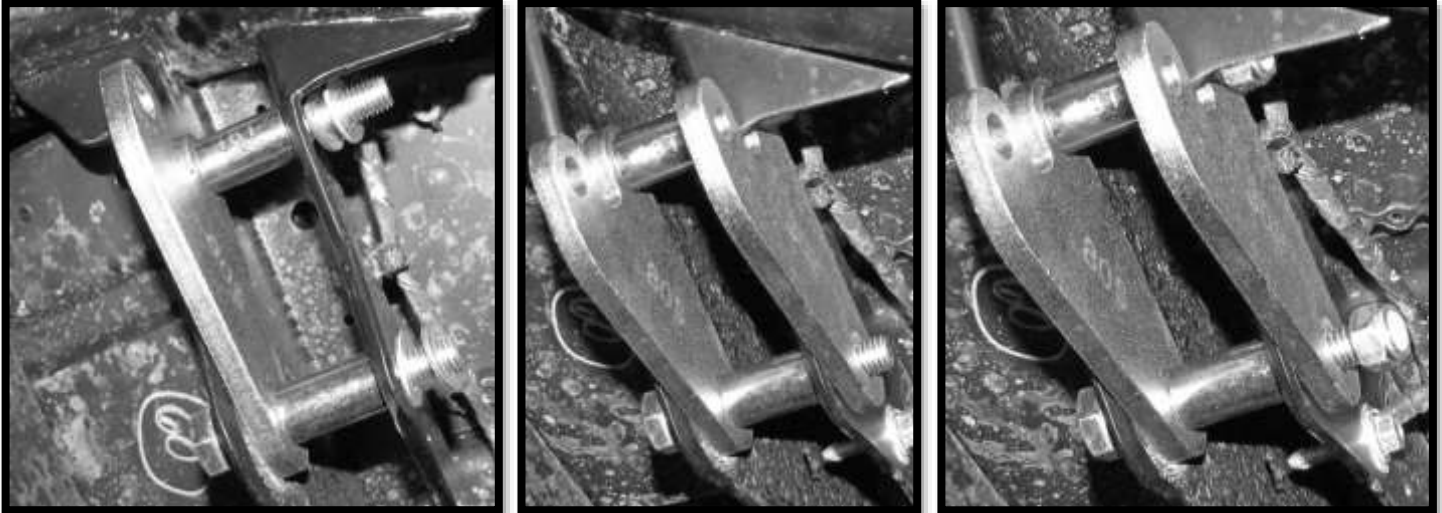

13) Connect the top of the shock to the lift brackets using **(1) 10x65mm hex bolt** and **(1) 10mm lock nut**. Once all the bolts are in place fasten them tight. Repeat the steps for the opposite side.

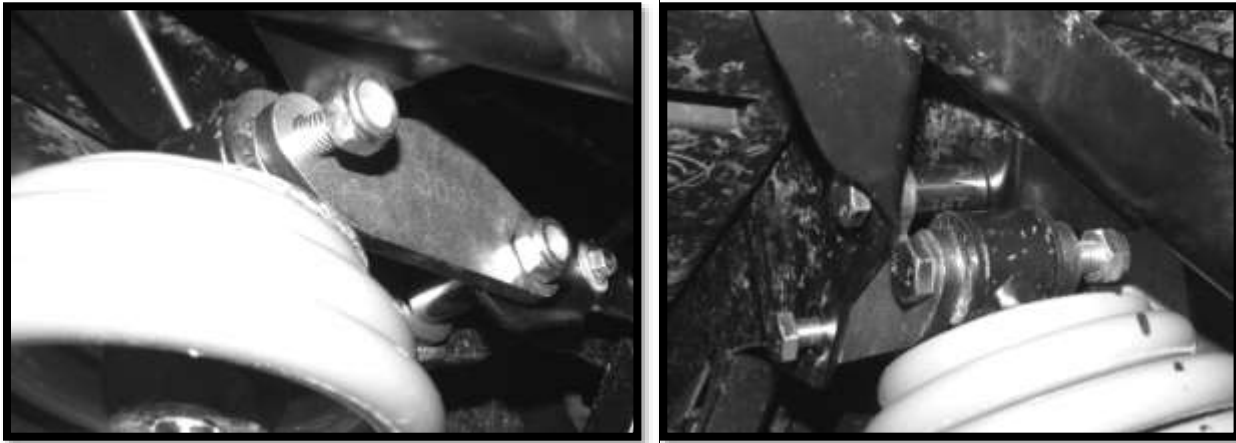

14) Reconnect the sway bar to the sway bar rods. Place **(3) 10mm washers** onto each of the rods. Connect bumpers and sway bars to the rods. Fasten tight.



- 15) **Check for clearance!!!!** Jack the front of the UTV up and let the front control arms drop to full extension. You need to check the axle boot clearance for the front axles. This is very important. When the control arms are at full extension the cv axle boots can come into contact with the lower control arm mounting tabs located on the frame. If you are using this lift kit in conjunction with lift springs and front forward control arms it can bring the cv boots even closer to the tabs. If you see the cv boots contacting the tabs for both sides will need to be slightly trimmed to allow for clearance. Take care not to damage the cv boot. If you do not feel that you can gain the clearance without damaging the cv axle boot, then you will need to remove the axle and clearance the tab.



- 16) When you have finished the opposite side reinstall the front wheels torque the lugs to factory specifications.

## **REAR LIFT INSTALLTION**

**(THE FOLLOWING INSTALLTION TAKES PLACE ON THE PASSENGER SIDE)**

- 1) Place UTV transmission in park. Place jack under center of UTV front end and lift until rear wheels clear the ground. Be careful to support the UTV properly so that A-arms and shocks can droop to full extension.
- 2) Remove the rear wheels.
- 3) Remove the nuts that secure the sway bar to the sway bar rod. Only loosen the nuts. Then remove the two rubber bushings.

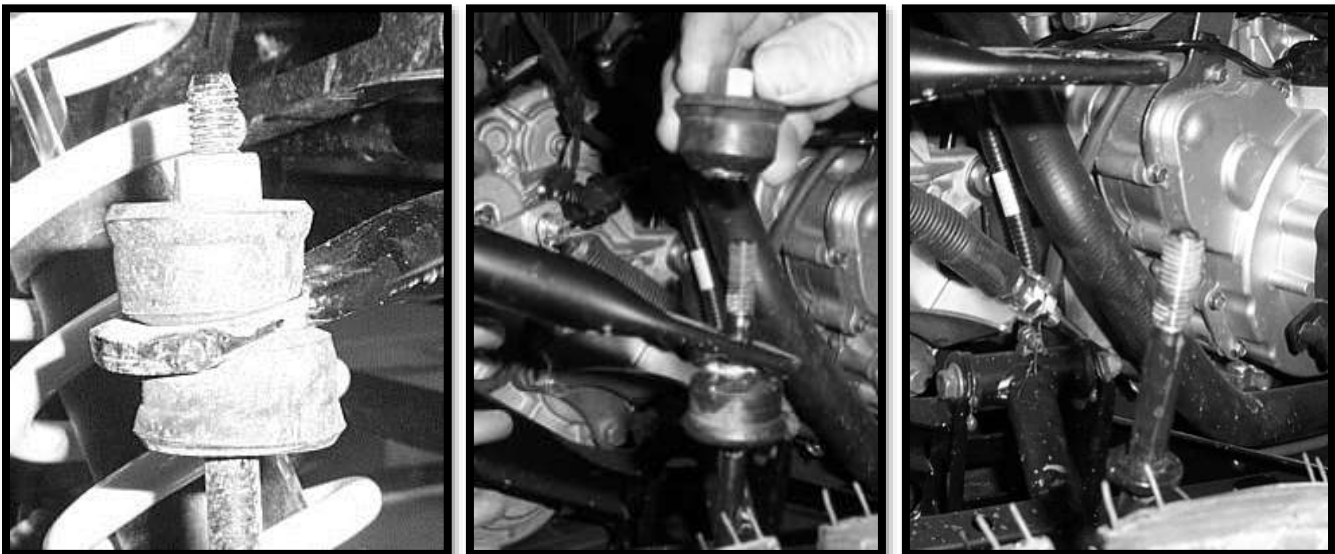



- 4) The rubber bushing that has the nut attached to it, remove the factory nut/washer.

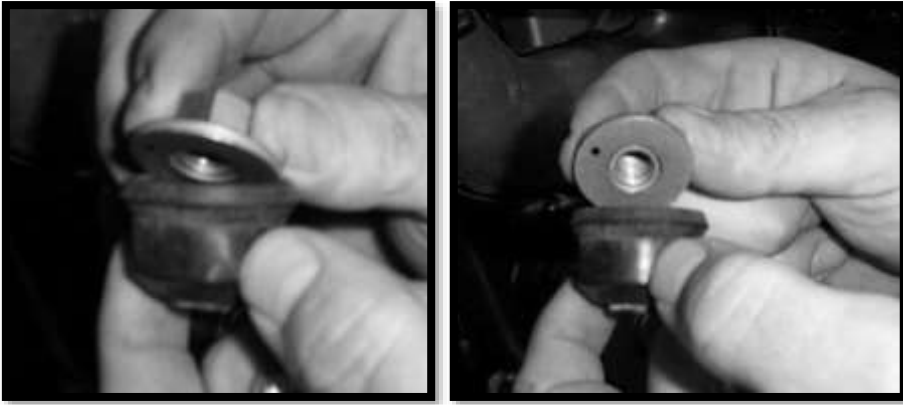

- 5) Replace it with (1) 7/16" flat washer and insert into it (1) 10mm x 65mm bolt.



- 6) Connect a 64N sway-bar extension bracket to the sway-bar rod.

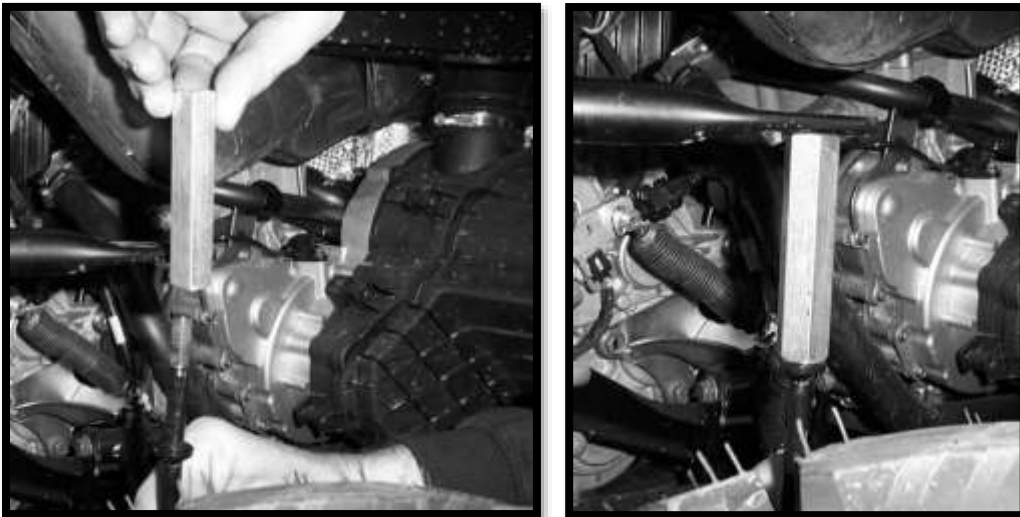

- 7) Insert the upper bushing and bolt through the sway-bar and connect it to the extension bracket with the lower bushing between the extension bracket and sway-bar.

**Note:** Leave the sway-bar loosely connected, this will make the remaining portions of the installation easier.



- 8) Disconnect the upper part of the rear shock from the frame.



- 9) Place the **(1) 71Y** rear lift bracket to the outside of the rear shock mount. It needs to be on the side that faces the front of the UTV. Insert **(2) 10x65mm hex bolts** through the bracket. Place **(2) 10mm washers** on each bolt. Insert the bolts through the shock mount tabs.

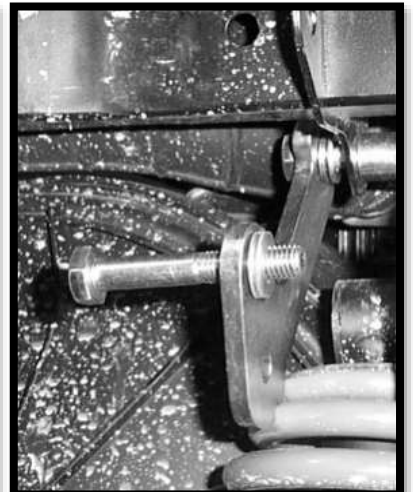
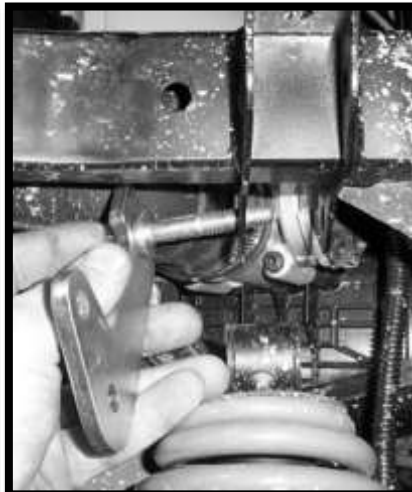

10) Now slide a **CCC** spacer on each of the bolts and insert the other rear lift bracket to the inside of the shock mount tab. Loosely fasten the bolts with **10mm lock nuts**.

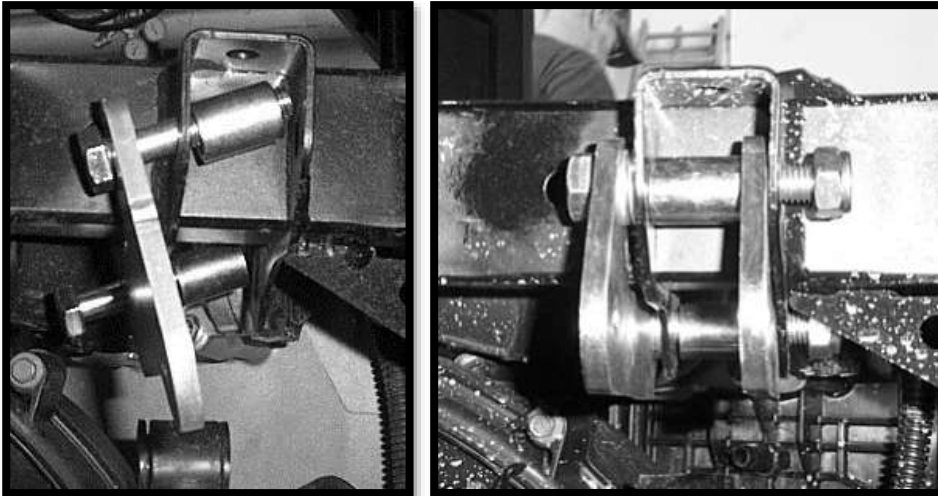

11) Connect the top of the shock to the lift brackets using **(1) 10x65mm hex bolt** and **(1) 10mm lock nut**.

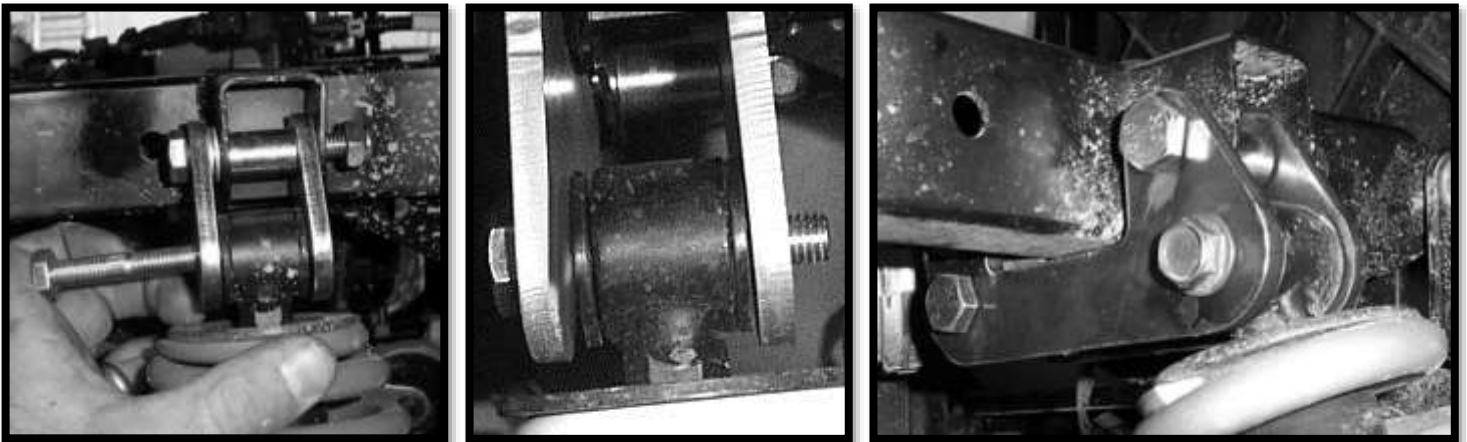

12) Reconnect the bottom of the shock to the control arm.

13) Once all the bolts are in place fasten them tight. Repeat the steps for the opposite side.

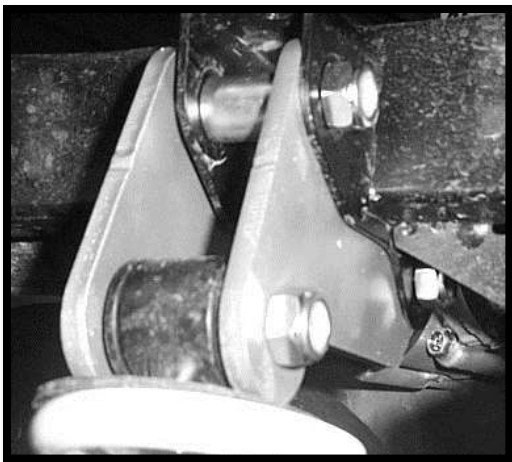

14) Tighten all nuts and bolts, including the sway-bar links. Place wheels back on the UTV and torque lugs to factory specifications.

## High Lifter Name Plate Installation

1. Raise the dump bed on the UTV. You will need to disconnect the shock from the bed to make the installation easier. Let the bed tilt all the way back once you disconnect the shock.



2. Next disconnect the tail light wires and move them out of the way.

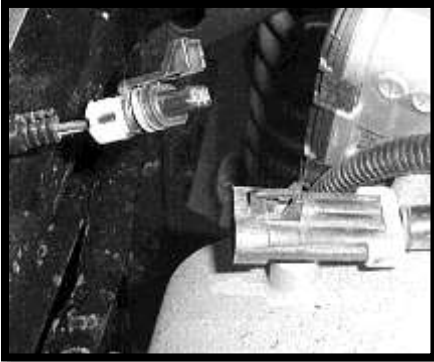

3. Now place the **61Z** name plate on the rear frame making sure to align the holes in bracket to the holes in the frame.

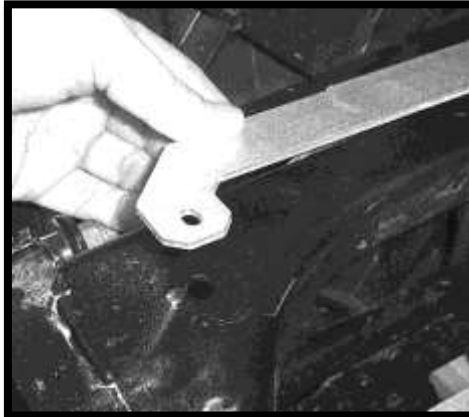

4. Connect the plate to the frame using the  $\frac{1}{4}$  x 1" hex bolt and  $\frac{1}{4}$ " washer on the top of the plate.



5. Fasten it tight under the frame using a ¼" washer and ¼" lock nut.



6. Once you have fastened the plate, reconnect the wires and shock to the dump bed. Then lower the bed.

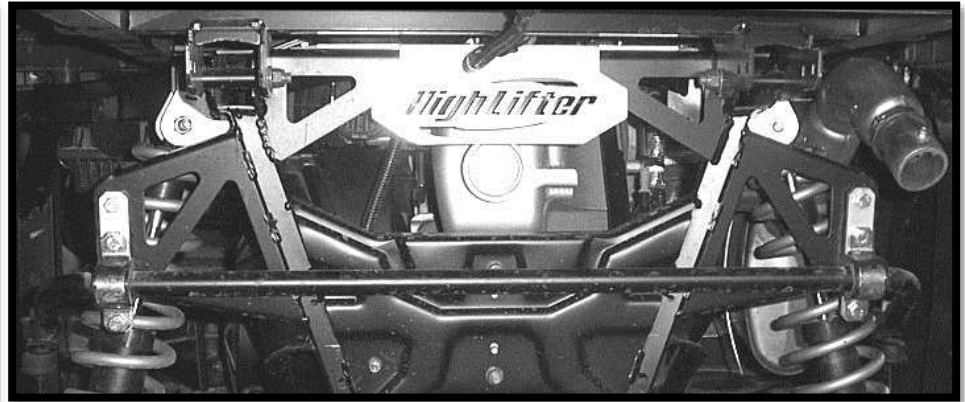

Thank You  
For Choosing  
**HIGHLIFTER**



### **High Lifter Lifetime Warranty**

From the beginning, High Lifter has engineered and manufactured some of the toughest, most durable products on the market. That's why this product comes with a Lifetime Warranty. It's our promise that High Lifter will never let you down.

- The **Lifetime Warranty** covers products sold to the original purchaser only and is not transferable. The term of the warranty is for the lifetime of the vehicle in question.
- Normal wear and tear items and finishes, such as, but not limited to: Heim joints, tie rod ends, ball joints, bearings, seals, bushings, bushing sleeves, zinc plating, powder coating, or chipping and discoloration of any finish is not covered.
- High Lifter will ship the replacement product after the returned product has been inspected by High Lifter staff.
- The warranty shall not include claims for damages, installation time or labor charges, economic losses, inconvenience, transportation, towing, down time, direct or indirect or consequential damages or delay resulting from any defect.
- The warranty does not apply to products that have been improperly applied or improperly installed.

### **Making a warranty claim**

1. All claims must be accompanied by the part and the original sales receipt or other acceptable proof of purchase from the original owner.
2. All warranties must be accompanied with a Return Merchandise Authorization (RMA) number. (Contact High Lifter at 318-524-2270 or 800-699-0947 for an RMA number)
3. When shipping the damaged product:
  - a. Write the RMA number on the outside of the box.
  - b. Also include the RMA number, proof of purchase and any notes inside the box.
  - c. Please keep your tracking number and shipment information.
4. The customer is responsible for shipping the product to High Lifter--return shipping within the lower 48 states will be paid by High Lifter products. With all warranty claims, only standard shipping services apply.
5. High Lifter will process your order within 24 business hours of receiving the returned item.
6. **Ship to:** High Lifter Products, 780 Professional Drive North, Shreveport, Louisiana 71105