

FS-RZR1-02-RZR 1000

HL

HIGHLIFTER

SEIZMIK™

FALCON RIDGE

SNORKEL YOUR ATV

SYSTEM 3
OFF-ROAD
Traction. Strength. Style.

EPI
PERFORMANCE

✉ sales@highlifter.com

☎ 800-699-0947 | 8:00am - 5:00pm CST

📍 7455 Atkinson Drive, Shreveport, LA 71129



www.highlifter.com

Parts Available For These Popular Brands and Others

POLARIS

can-am



HONDA

Kawasaki

YAMAHA

PRODUCT DISCLAIMER

The installation of products sold or manufactured by High Lifter Products, Inc. including, but not limited to suspension components such as lift kits, gear reduction lifts, frame stiffener kits, snorkels, and tires that exceed the original specifications for the vehicle, may change the vehicle's center of gravity and handling characteristics both on- and off-road. You are aware that the installation of tires that are larger than original vehicle specifications may reduce the effectiveness of the braking system. Use of these products may place added stress to the original factory vehicle components which could cause them to weaken or possibly fail.

Products sold or manufactured by High Lifter Products, Inc. are intended for off-road use only. Operation of a vehicle modified with these products on a road could result in serious bodily injury or death, and such operation may violate the laws of your state or municipality. You agree to operate your vehicle exclusively in the manner intended by the vehicle manufacturer. You agree that failure to safely and reasonably operate your vehicle could result in serious bodily injury or death, and that, as a result of installation of this product(s) to your vehicle, extreme care must be taken to prevent vehicle rollover or loss of control, which may be more likely to occur as a result of said modifications. You will avoid unsafe maneuvers, including sudden sharp turns or other abrupt maneuvers, which could make a vehicular accident more likely. You understand that High Lifter Products, Inc. is not responsible or liable for any damages or any injuries to yourself or your passengers that could occur upon possible accidents due to driver error, incorrect installations, bad judgment, incompatibility with other aftermarket accessories or natural disasters to the fullest extent allowable by law.

You will have all vehicle occupants fasten seatbelts, if equipped, and wear proper safety equipment, such as DOT approved helmet and eye protection prior to operating the vehicle. You understand and acknowledge that failure to wear proper safety equipment may increase the risk of serious bodily injury or death to yourself and any passengers.

Proper installation of products sold or manufactured by High Lifter Products, Inc. requires knowledge of the factory recommended procedures for removal and installation of original equipment components. Installation of these products without proper knowledge and experience may affect the performance of these components and the safety of the vehicle and cause serious bodily injury or death. It is strongly recommended that a certified mechanic familiar with the installation of similar components perform the product(s) installation.

Prior to installing any products sold or manufactured by High Lifter Products, Inc., you will perform or cause to be performed an inspection of their vehicle to confirm its condition is suitable for the installation of these products. A proper inspection of the vehicle includes confirmation that the vehicle has not been in a collision and is free of corrosion. If the vehicle is suspected to have been in a collision or misused, or is otherwise unsuitable for modification, you will not install the product(s). You will continue to inspect the vehicle prior to each use to confirm its condition is suitable for its intended use, and you acknowledge that the failure to do so may result in serious bodily injury or death, as well as damage to the vehicle itself.

You will install any warning labels provided with the product so it may be prominently seen by yourself and all passengers. You will notify all passengers of the modifications performed to your vehicle prior to operation.

Insurance companies may handle coverage of a modified vehicle differently. Please check with your insurance carrier prior to modifying the vehicle to ensure your coverage remains sufficient.

Installation of this product(s) may void your vehicle warranty. If this is a concern, please check with the manufacturer or dealer before purchase or installation of this product(s).

HIGHLIFTER



HIGH LIFTER LIMITED LIFETIME WARRANTY

High Lifter offers a Limited Lifetime Warranty to the original purchaser that our product shall be free from defects in material and workmanship for the life of the product if utilized in accordance with the manufacturer's instructions for installation and operation of said products.

LIMITED LIFETIME WARRANTY EXTENDS TO THE FOLLOWING PRODUCT LINES:

- **Lift Kits (Signature, Standard and Big Lifts)**
- **Control Arms**
- **Trailing Arms**
- **Radiator Relocation Kits**
- **Portal Gear Lifts**
- **Wheel Spacers**
- **Tow Hooks**
- **Control Arm Link Kits**

Damages to vehicle or any other object during the installation, use, or removal of High Lifter products are not covered under this warranty. Normal wear items included with any of the products covered under this Limited Lifetime Warranty are excluded from coverage. These items include, but are not limited to heim joints, tie rods, bearings, bushings, seals, gaskets, zinc plating, painted and powder coated finishes. Other exclusions of coverage under this warranty include, but are not limited to: damage or product failure due to improper installation, lack of maintenance, product modification, abuse, collision or use on vehicles for which product was not designed, repairs performed by anyone other than approved High Lifter personnel or made using non-High Lifter components. This warranty is valid for the original purchaser only and is non-transferable. High Lifter reserves the right to inspect any product before determining if the claim is valid and covered under this warranty. Claims determined to be caused by reasons other than a manufacturer defect will be rejected and an estimate for repair or cost of a replacement product if a repair is not possible, will be provided.

This warranty is exclusive and is in lieu of any implied warranty of merchantability, fitness for a particular purpose or other warranty of quality, whether express or implied, except the warranty of title.

WARRANTY PROCESSING

If you suspect your product is defective, **DO NOT** disassemble the product to determine the cause without prior approval as it may void your warranty status. This is especially true with our Portal Gear Lift. To begin the claim process, please e-mail our warranty team at warrantycare@highlifter.com and include the following in the e-mail:

- Your full name, address and contact phone number.
- The year, make and model of your vehicle
- The part number of the product
- Photos of the product installed, and vehicle product is installed on
- Proof of Purchase (Required for all warranty claims and you must be the original purchaser)

Once a claim is created, you will receive a return authorization number (RMA). Write this number on the outside of the box containing your defective product and include it along with your name and contact information inside the box. Product must be returned in the original box or a box of equal strength and packaging. Product sent without an RMA number visible on the outside of the box or sent COD will be refused. Ship your product to the following address:

High Lifter Products, Inc.
Attn: Returns 7455 Atkinson Dr, Shreveport, LA 71129

Once your product is received, we often have your replacement or repaired product shipped back to you within 3-business days of receiving it. Please note that High Lifter is not responsible for shipping charges on product returned for warranty or repair, including duties and fees required by those residing outside the United States.

THANK YOU FOR CHOOSING
HIGHLIFTER

#79-16137

PARTS

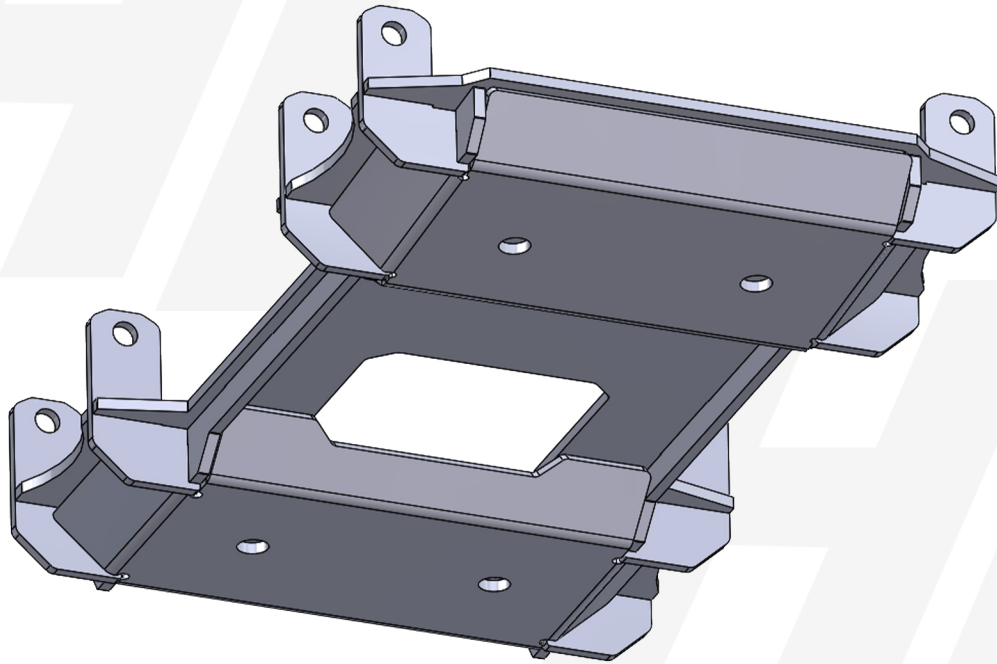

**FRONT FRAME STIFFENER
79-15222-B1
(1 EACH)**

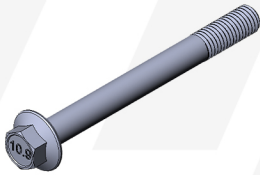

**10MM X 110MM BOLT
(4 EACH)
54-61628**



**10MM NYLON LOCK NUT
(4 EACH)
54-61038**

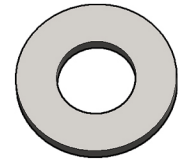

**10MM WASHER
(4 EACH)
54-61026**

STEP 1

LIFT UTV WITH JACK



PLACE JACK UNDER THE CENTER OF FRONT AND LIFT UNTIL THE WEIGHT IS OFF THE SUSPENSION. BE CAREFUL TO SECURE PROPERLY SO IT IS STABLE ON THE JACK OR JACK STANDS. REMOVE TIRES.



STEP 2

REMOVE FACTORY NUTS AND BOLTS

REMOVE ALL FOUR OF THE STOCK 15MM BOLTS. YOU WILL NEED A 15MM SOCKET AND A 17MM WRENCH.

NOTE: YOU WILL USE THE NEW BOLTS, WASHERS AND NUTS THAT WERE INCLUDED IN THIS KIT TO INSTALL THE NEW FRAME STIFFENER.

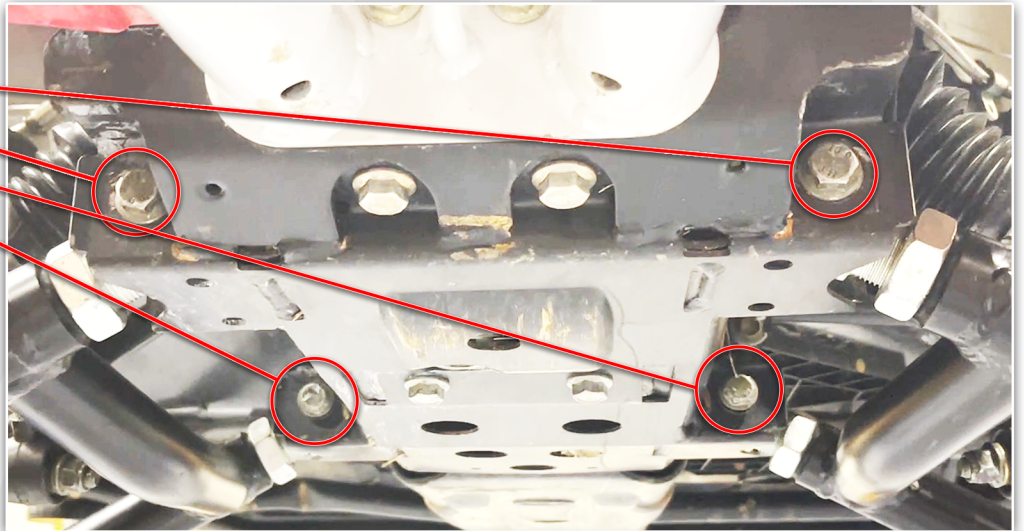

PARTS NEEDED FOR THIS STEP

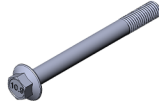

10MM X 100MM BOLT
(4 EACH)



10MM NYLON LOCK NUT
(4 EACH)

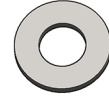

10MM WASHER
(4 EACH)

NOTE: THIS STEP IS EASIER WITH TWO PEOPLE.

FIRST, LINE UP THE FRAME STIFFENER. ONCE ALIGNED INSTALL THE FIRST 10MM BOLT.

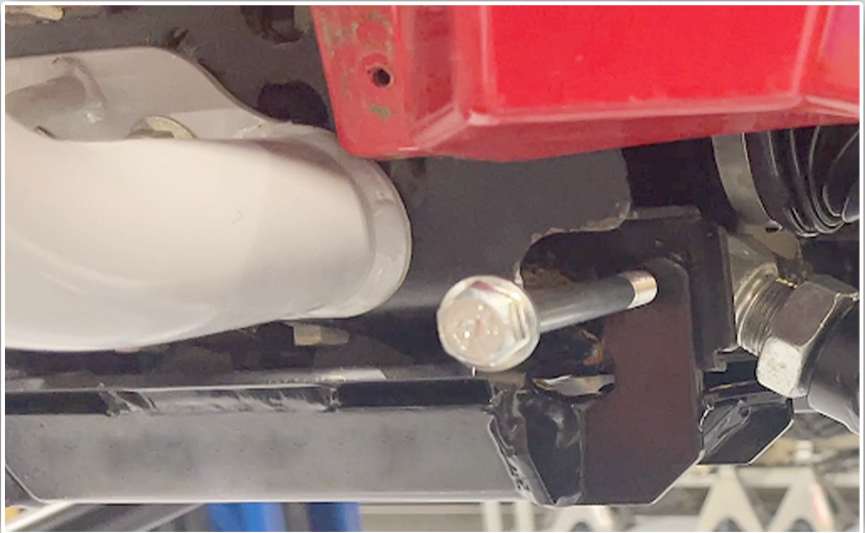
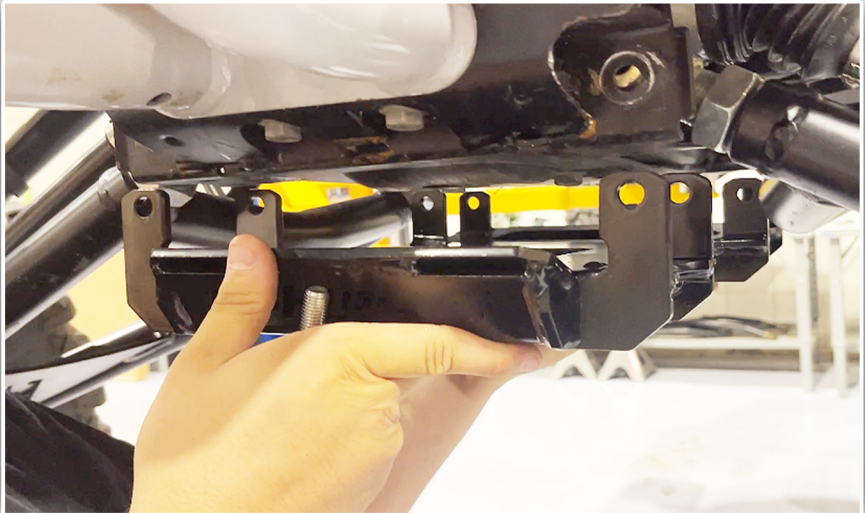

REPEAT THE PREVIOUS STEP FOR THE REMAINING THREE 10MM BOLTS.



**YOU WILL NEED A
17MM SOCKET AND
15MM WRENCH FOR
THIS STEP.**

**INSTALL ONE 10MM
WASHER BEFORE YOU
THREAD A 10MM NUT
ONTO THE 10MM BOLT.**

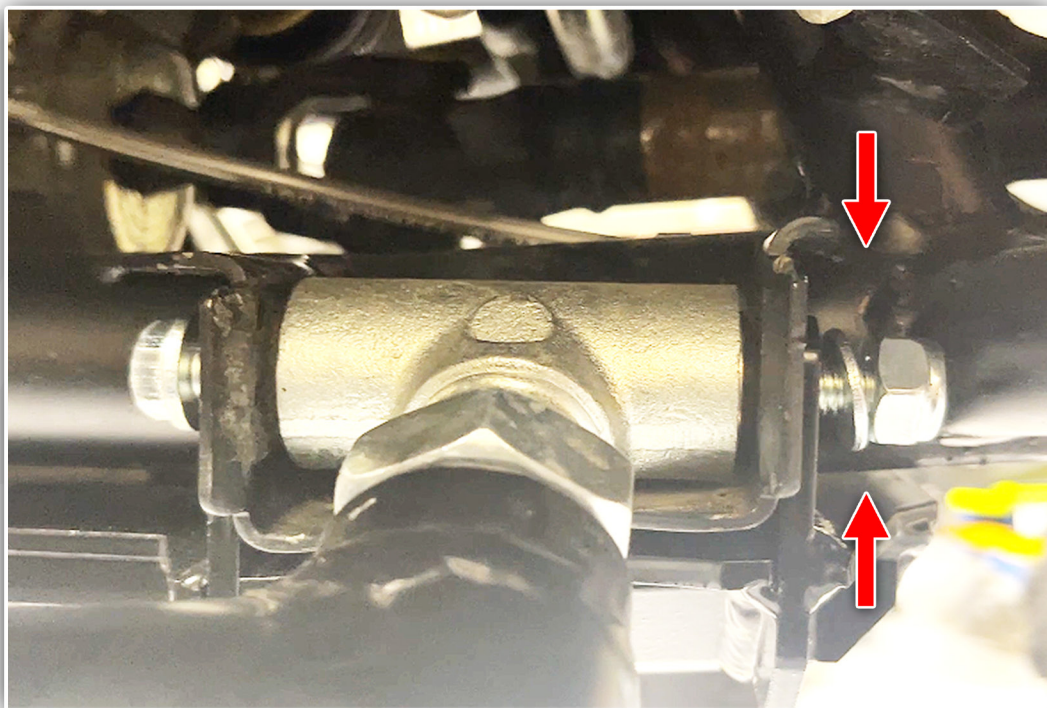

**ONCE ALL BOLTS AND
NUTS ARE IN PLACE
TIGHTEN ALL DOWN TO
SPECS.**

**REINSTALL TIRES THEN
LOWER THE JACK.**

**TORQUE SPECS ON
FOLLOWING PAGE.**

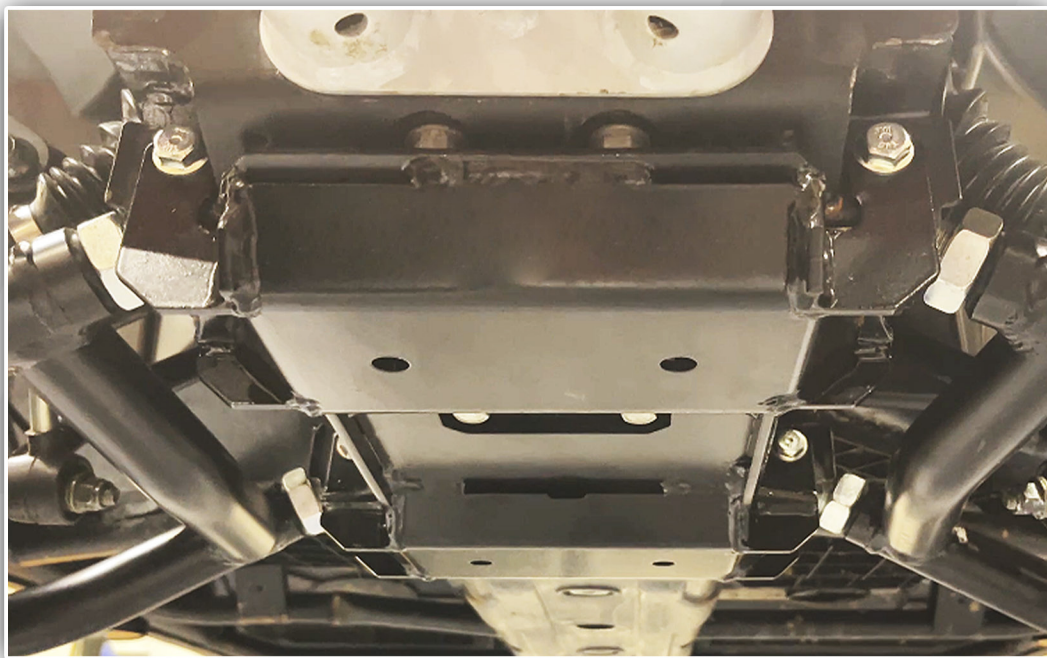

Thank You For Choosing

HIGHLIFTER

THE TORQUE VALUES CAN ONLY BE ACHIEVED IF THE NUT (OR TAPPED HOLE) HAS A PROOF LOAD GREATER THAN OR EQUAL TO THE BOLTS MINIMUM ULTIMATE TENSILE STRENGTH. CLAMP LOAD IS CALCULATED AS 75% OF THE PROOF LOAD WHEN SPECIFIED BY THE STANDARD. ASTM A307 UTILIZED 75% OF 36,000 PSI.

TORQUE VALUES FOR 1/4 AND 5/16 IN SERIES ARE IN INCH POUNDS.

ALL OTHERS ARE IN FOOT-POUNDS.

TORQUE-TENSION RELATIONSHIP FOR A307A, GRADE 5 & 8

NOMINAL DIA. (in.)	THREADS PER INCH	TENSILE STRESS AREA (Sq. in.)	SAE J429 - GRADE 5				SAE J429 - GRADE 8			
			CLAMP LOAD (lbs.)	TIGHTENING TORQUE			CLAMP LOAD (lbs.)	TIGHTENING TORQUE		
				K=0.15	K=0.17	K=0.20		K=0.15	K=0.17	K=0.20
UNIFIED COARSE THREAD SERIES										
1/4	20	0.0318	2029	76 in-lbs	86 in-lbs	101 in-lbs	2864	107 in-lbs	122 in-lbs	143 in-lbs
5/16	18	0.0524	3342	157	178	209	4719	221	251	295
3/8	16	0.0775	4940	23 ft-lbs	26 ft-lbs	31 ft-lbs	6974	33 ft-lbs	37 ft-lbs	44 ft-lbs
7/16	14	0.1063	6777	37	42	49	9568	52	59	70
1/2	13	0.1419	9046	57	64	75	12771	80	90	106
9/16	12	0.1819	11599	82	92	109	16375	115	130	154
5/8	11	0.2260	14408	113	128	150	20340	159	180	212
3/4	10	0.3345	21322	200	227	267	30101	282	320	376
7/8	9	0.4617	29436	322	365	429	41556	455	515	606
1	8	0.6057	38616	483	547	644	54517	681	772	909
1-1/4	7	0.9691	53786	840	952	1121	87220	1363	1545	1817
1-1/2	6	1.4053	77991	1462	1657	1950	126473	2371	2688	3162
FINE THREAD SERIES										
1/4	28	0.0364	2319	87 in-lbs	99 in-lbs	116 in-lbs	3274	123 in-lbs	139 in-lbs	164 in-lbs
5/16	24	0.0581	3702	174	197	231	5226	245	278	327
3/8	24	0.0878	5599	26 ft-lbs	30 ft-lbs	35 ft-lbs	7905	37 ft-lbs	42 ft-lbs	49 ft-lbs
7/16	20	0.1187	7568	41	47	55	10684	58	66	78
1/2	20	0.1600	10197	64	72	85	14396	90	102	120
9/16	18	0.2030	12940	91	103	121	18268	128	146	171
5/8	18	0.2560	16317	127	144	170	23036	180	204	240
3/4	16	0.3730	23776	223	253	297	33566	315	357	420
7/8	14	0.5095	32479	355	403	474	45853	502	568	669
1	14	0.6799	43343	542	614	722	61190	765	867	1020
1-1/4	12	1.0729	59548	930	1055	1241	96565	1509	1710	2012
1-1/2	12	1.5810	87747	1645	1865	2194	142292	2668	3024	3557

TORQUE-TENSION RELATIONSHIP FOR METRIC FASTENERS

NOMINAL DIA. (in.)	PITCH	8.8 CLASS 8.8				10.9 CLASS 10.9				12.9 CLASS 12.9			
		CLAMP LOAD (lbs.)	TIGHTENING TORQUE			CLAMP LOAD (lbs.)	TIGHTENING TORQUE			CLAMP LOAD (lbs.)	TIGHTENING TORQUE		
			LUBRICATED (ft-lbs)	ZINC PLATED (ft-lbs)	PLAIN&DRY (ft-lbs)		LUBRICATED (ft-lbs)	ZINC PLATED (ft-lbs)	PLAIN&DRY (ft-lbs)		LUBRICATED (ft-lbs)	AS RECEIVED (ft-lbs)	PLAIN&DRY (ft-lbs)
4	0.7	858	1.7	1.9	2.3	1228	2.4	2.7	3.2	1436	2.8	3.2	3.8
5	0.8	1387	3.4	3.9	4.5	1985	4.9	5.5	6.5	2319	5.7	6.5	7.5
6	1	1968	5.8	6.6	7.7	2816	8.3	9.4	11.1	3291	9.7	11.0	13.0
7	1	2822	9.7	11.0	13.0	4039	13.9	15.8	18.5	4720	16.3	18.4	21.7
8	1.25	3580	14.1	16.0	18.8	5123	20.2	22.9	26.9	5987	23.6	26.7	31.4
10	1.5	5671	27.9	31.6	37.2	8115	39.9	45.2	53.2	9484	46.7	52.9	62.2
12	1.75	8240	48.7	55.1	64.9	11792	69.6	78.9	92.8	13781	81.4	92.2	108.5
14	2	11289	77.8	88.1	103.7	16154	111.3	126.1	148.4	18879	130.0	147.4	173.4
16	2	15320	121	137	161	21924	173	196	230	25622	202	229	269
18	2.5	18822	167	189	222	26934	239	270	318	31477	279	316	372
20	2.5	23938	236	267	314	34256	337	382	449	40034	394	446	525
22	2.5	29669	321	364	428	42457	460	521	613	49619	537	609	716
24	3	34471	407	461	543	49329	582	660	777	57649	681	771	908
27	3	44924	597	676	796	64288	854	968	1139	75132	998	1131	1331
30	3.5	54819	809	917	1079	78448	1158	1312	1544	91680	1353	1534	1804
33	3.5	67821	1101	1248	1468	97055	1576	1786	2101	113425	1842	2087	2455
36	4	79866	1415	1603	1886	114291	2024	2294	2699	133569	2366	2681	3154

TORQUE VALUES CALCULATED FROM FORMULA T=KDF:

K=0.15 FOR "LUBRICATED" CONDITIONS

K= 0.17 FOR ZINC PLATED AND DRY CONDITIONS, ALSO THE USE OF VARIOUS FORMS OF THREAD LOCKERS HAVE A SIMILAR K VALUE

K=0.20 FOR PLAIN DRY CONDITIONS

D= NOMINAL DIAMETER

F=CLAMP LOAD

NOTE: WHEN USING ZINC PLATED (LUBRICATED WITH WAX) TOP LOCK NUTS, THE K VALUE CAN VARY FROM 0.12 TO 0.16.

CAUTION: ALL MATERIAL INCLUDED IN THESE CHARTS IS ADVISORY ONLY. EXTREME CAUTION SHOULD BE USED WHEN USING A FORMULA FOR TORQUE/TENSION RELATIONSHIPS. TORQUE IS ONLY AN INDIRECT INDICATION OF TENSION. UNDER/OVER TIGHTENING OF FASTENERS CAN RESULT IN COSTLY EQUIPMENT FAILURE OR PERSONAL INJURY.