

ICE CRUSHER HEATERS

Polaris General w/ Fosgate

ICCH-BD-C-POLGEN-FOS

1x Hole Saw Arbor



233

1x 1 1/4" Hole Saw

235

236

234

1x 2 1/8" Hole Saw

1x 3" Hole Saw



2x #16 Hose Clamp



226

12x #10 Hose Clamp



228

2x #10 Hose Clamp



243

1x 1" Brass Y

1x 3-Way Ball Valve



246

4x 90 Degree Elbows



321

2x 1 1/4" Rubber Grommets



221

4x - 1/4" Serrated Flange Nuts



420

2x - M6 x 12mm Flat Head Screws



453

1x - 3 Speed Fan Switch

1x - Switch Nut

1x - #2 Knob



333

345

331

1x - #1035 Bracket

#1035

1x - #1057 Bracket

#1057



1x - Wiring Harness



213

1x - Zip Ties



214

1x - Polaris Pulse Connector



405

3x - Butt Splice Connectors



404



504

12' 5/8" Hose (2 Seat)
15' 5/8" Hose (4 Seat)



693

1x Compact Heater



505

40" - 2" Duct Hose



#1141

1x #1141 Bracket



501

4 x 2" Vents



502

2 x 3" Vent



503

2 x 2" Y's

Polaris General with Fosgate Sub Ice Crusher Heater



Please read all instructions before beginning installation. It is easiest to physically split the instructions in two halves, one the text portion and the other the picture portion. It makes referring back and forth between the two much simpler.

When working on cooling systems always allow vehicles to cool to avoid being burned or scalded by hot coolant.

Always disconnect vehicles negative battery lead before working on electrical systems.

Please note: *Before drilling* any holes check area behind firewall/dash panels to make sure no damage or interference with equipment will occur by drilling holes and fitting of vents.

1. Pre-Installation

- a. Remove Windshield if applicable, for easier access to the interior remove Driver and Passengers Doors.
- b. Remove the front Hood but unlocking the twist locks.
- c. Remove the Top Dash as shown in Figure 1 and Figure 2.
- d. Remove the Passenger Side Rear Mud Guard as shown in Figure 3.
- e. Remove the Passenger Side Seat
- f. Remove the Passenger Side Center Tunnel Cover for best access of Heater Hose Routing as shown in Figure 4 and Figure 5.

2. Panel Modification for Vents

- a. Cut out the Defrost Vent Templates and position them on the top dash as shown in Figure 6. Mark the hole centers, **VERIFY NOTHING IS BEHIND THE LOCATION** and drill using the 2 1/8" Hole Saw included in the kit. Debur as necessary. **Installation Tip: After cutting the 2" vent holes, use a razor blade to cut a small "V" shaped notch anywhere along the hole. Each 2" Vent has an anti-rotation notch molded into it, fit the notch into the 'V' groove for easier install**, as shown in Figure 7.
- b. Cut out the Driver and Passenger Side Vent Templates and position them as shown in Figure 8 and Figure 9. Mark the hole centers and drill using the 2 1/8" Hole Saw included in the kit. Debur as necessary and cut the "V" shaped notch as mentioned before.
- c. Locate the dimples in the Center Tunnel on the Driver and Passenger Side and drill using the included 3" Hole Saws as shown in Figure 10 and Figure 11. Debur as necessary and cut the "V" shaped notch as mentioned before.

Polaris General with Fosgate Sub Ice Crusher Heater

- d. Cut out the Fan Switch Template, place it on the dash to the left of the center console and transfer the hole center. Drill using a 7/16" drill bit. Debur as necessary.

3. Heater Assembly and Mounting

- a. Insert the 1 ¼" Grommets as shown in Figure 13.
- b. Attach the #1141 Heater Mounting Bracket to the Heater Unit using the (2) M6 x 12mm Flat Heater Screws as shown in Figure 14.
- c. If the copper ports of the heater have black plugs in the end, remove them with a pliers. Be sure not to pinch the copper ports as they will dent.
- d. Cut 2 ½" piece of 5/8" Heater Hose and attach it to the Heater Unit as shown in Figure 15. Insert (1) 90 Degree Fitting as shown. Secure using #10 Hose Clamps.
- e. Cut a 4 ½" piece of 5/8" Heater Hose and attach it to the Heater Unit as shown in Figure 15. Insert (1) 90 Degree Fitting as shown. Secure using #10 Hose Clamps.
- f. Cut (2) 12" pieces of 5/8" Heater Hose and attach the hoses to the 90 Degree Fittings as shown in Figure 16. Secure using #10 Hose Clamps.
- g. Insert the (2) 12" pieces of 5/8" Heater Hose into the 1 ¼" Grommets as shown in Figure 17. Use soapy water or windex to lubricate the hose and Grommets for easier install. Press the hoses into the firewall until the (4) threaded studs on the Heater Bracket can be pushed through the Firewall.
- h. Secure the Heater Assembly to the Firewall using (4) ¼" Serrated Flange Nuts as shown in Figure 18.

4. Coolant Plumbing

- a. Cut a 6' piece (9' if four seat version) of the 5/8" Heater Hose. From the Center Tunnel, route the 5/8" Heater Hose to the front and rear of the vehicle following the OEM Coolant lines. Refer to Figure 19 and Figure 20.
- b. Route the 6' (or 9') portion of 5/8" Heater Hose at the front Passenger Side of the vehicle toward the heater unit. Install one of the remaining 90 Degree Fitting to the end of the hose and attach the inner most 5/8" Heater Hose as shown in Figure 21, secure with #10 Hose Clamps. Pull excess Heater Hose toward the rear.
- c. From the excess Heater Hose at the rear of the vehicle, cut a 24" piece of the hose and insert the remaining 90 Degree Fitting to the end and secure with #10 Hose Clamps. Insert the 90 Degree Fitting into the remaining hose at the heater as shown in Figure 22
- d. Step "D" removed.
- e. **INSTALLATION NOTE: Before proceeding, ensure the vehicle engine is completely cold. Drain coolant or if Hose Clamp Off tools are available, clamp off the areas in front of and behind the locations where cuts will be made in the coolant system. Never cut into the vehicles cooling system if the vehicle is warm.**
- f. Assemble the 1" Aluminum Y's using (3) wraps of Teflon Tape on the Brass 5/8" Barbs. Tighten it snug into the Y's as shown in Figure 24
- g. Locate the Lower Radiator Hose viewed from the Passenger Side Wheel Well, make a 1"-1.5" Section of the hose as shown in Figure 25. Cut this section of hose out.
- h. Insert the 1" Aluminum Y as shown in Figure 26. Secure using #16 Hose Clamps for the larger hoses. Insert the 5/8" Heater Hose, and secure with a #10 Hose Clamp.

Polaris General with Fosgate Sub Ice Crusher Heater

- i. Step "I" removed
- j. From the Passenger Side Rear Wheel well, locate the Oil Cooler Bypass Hose toward the front of the engine as shown in Figure 27. Cut a 1" to 1.5" section of hose approximately at the yellow mark shown in Figure 27. Insert the 3-Way Ball Valve in the Oil Cooler Bypass Hose with the arrow on the valve, see Figure 28, following the flow direction as shown in Figure 27. Secure the valve with the supplied #10 Hose Clamps. Cut the 5/8" Heater Hose to length and connect it to the valve, using a #10 Hose Clamp to secure it.
- k. Zip Tie the Heater Hoses away from any hot and or moving parts of the vehicle.

5. Wiring Connections

- a. From the top dash pass the White Four Pin Connector behind the glove box on the Passenger Side of the vehicle until it appears near the heater. Connect the plug to the connector on the heater unit as shown in Figure 29.
- b. Route the remaining harness toward the Driver Side. Route the Blue single conductor wire and Black single conductor wire through the Firewall toward the Pulse Connector Panel.
- c. Use the Butt Splice Connectors to connect the Blue Heater Harness Wire to the YELLOW Pulse Connector wire. Connect the Black Heater Harness Wire to the BLUE Pulse Connector Wire. The Red Wire on the Pulse Connector can be left blank or crimped with the remaining Butt Splice Connector and zip tied to the harness, it will not be used. See Figure 30 and Figure 31.
- d. Insert the switch through the 7/16" hole drilled earlier, place the Red (#1035) panel over the switch shaft, place the Black (#1057) panel over the Red panel and secure using the 7/16" Low Profile Nut. Press the knob onto the switch shaft. Connect the wiring harness from behind. Zip tie excess harness together. See Figure 32.
- e. Reconnect the vehicle battery and test that each speed of the heater fan is working.

6. Duct Hose Routing

- a. Use the 2" Duct Hose and Figure 33 to cut the various hose lengths of hose.
IMPORTANT NOTE: HOSE DIMENSIONS ARE IN A COMPRESSED STATE.
- b. Connect the 2" Duct Hoses as shown working from back to front and from the heater unit up, use a zip tie at each connection to ensure they do not slip off the different fittings. See Figure 34, Figure 35, Figure 36, Figure 37.
- c. Position the Top Dash roughly back into place to allow the hoses to run through the dash.
- d. Insert the 2" Vents into each hose, secure with a zip tie, cut the zip tie flush to the head.
INSTALLATION TIP: Tip the head of the zip tie into the vent hole, once the head of the zip tie is in the hole, tilt the rest of the vent into the hole, align the anti-rotation notch with the 'V' cut in each hole and press on the outside of the vents until they click into place.

7. Reassembly

- a. Secure duct hoses, wires and 5/8" Heater Hoses away from sharp, moving or hot parts of the vehicle using the remaining zip ties.
- b. Reinstall the Center Tunnel Panel, Passenger Seat, Top Dash, Rear mud guard and any other pieces removed during installation.

Polaris General with Fosgate Sub Ice Crusher Heater

8. Coolant Bleeding

- a. Refill the reservoir at the front of the vehicle using manufacturer approved coolant. Open the radiator cap and fill the radiator completely. Start the vehicle and let it run at idle. Use a 10mm Wrench top the Bleeder Screw located under the aluminum heat shield shown in Figure 38. The Bleeder Screw is located between the two exhaust ports as shown in Figure 39. Open the screw several turns until air bubbles or coolant come out. Keep the screw open until a continuous stream of coolant comes out and no more air bubbles come out. Tighten it back down snug.
- b. Check the fluid level in the radiator and fill as needed. Replace the radiator cap.
- c. Use a clamp to temporarily clamp off the Oil Cooler Bypass Hose as shown in Figure 40. This will force all the coolant to go through the heater system and flush air bubbles into the radiator.
- d. Run the vehicle at a fast idle. Monitor the vehicle temperature, do not allow the vehicle temperature to exceed 210 degree Fahrenheit. Run the vehicle until the radiator fan has turned on and cooled the vehicle to normal operating temperature. Turn off vehicle and check for leaks at all connection points.
- e. Allow vehicle to cool completely (this can take several hours), recheck cooling system level, fill as required. Refill cooling system as per manufacturer's procedure. Start and run the vehicle at a fast idle and run up to normal operating temperature. Check heater operation while running the vehicle. Run the vehicle until the radiator fan has turned on and off, then turn the vehicle off and check for leaks. Allow vehicle to cool and recheck cooling system level, fill as required.
- f. If the heater fails to blow hot/warm air once the vehicle is up to operating temperature, there is likely an air lock in the heater unit. Temporarily block off the top/inlet radiator hose at the radiator. Start and run vehicle up to operating temperature. Feel the outlet/lower hose from heater until it feels hot. The heater now should be blowing hot/warm air. Remove clamp from radiator hose. The heater should continue to blow hot/warm air. This procedure may have to be repeated a few times to remove air from system. Allow vehicle to cool, restart the vehicle and run up to operating temperature, recheck heater operation. **Please note:** Heater output will be limited at idle, all testing should be done at a fast idle.

Polaris General with Fosgate Sub Ice Crusher Heater

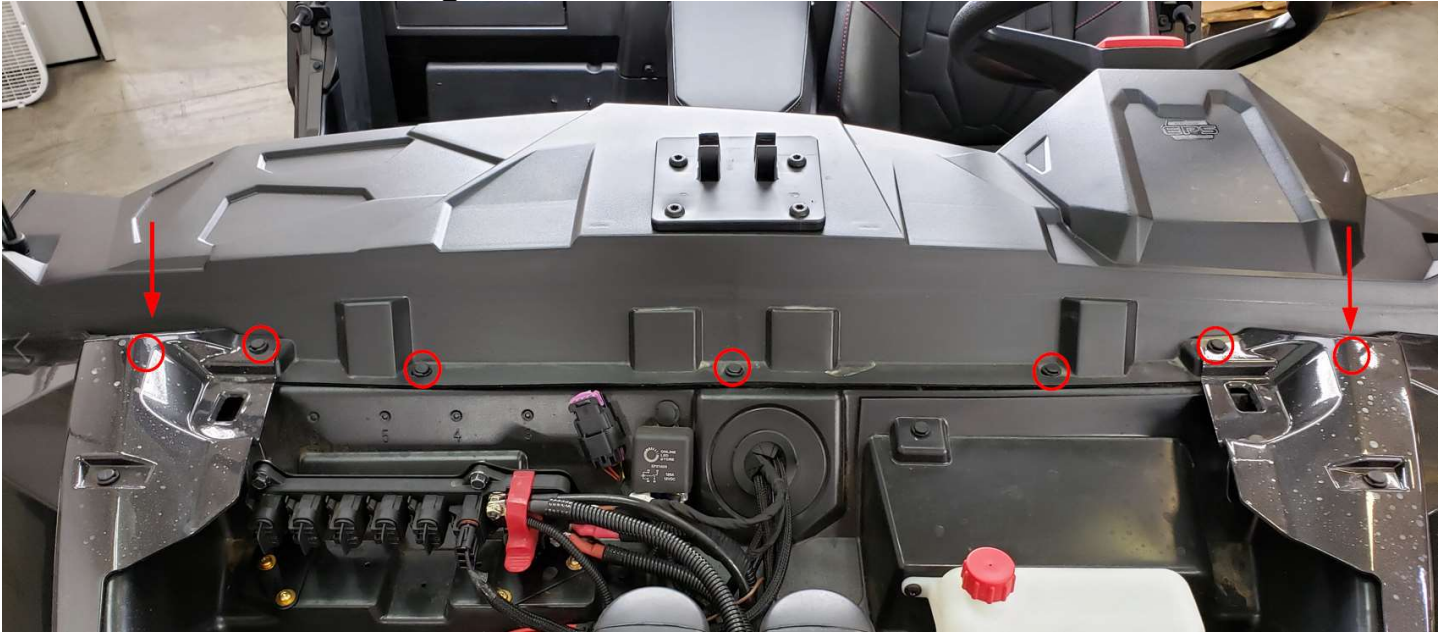

Figure 1

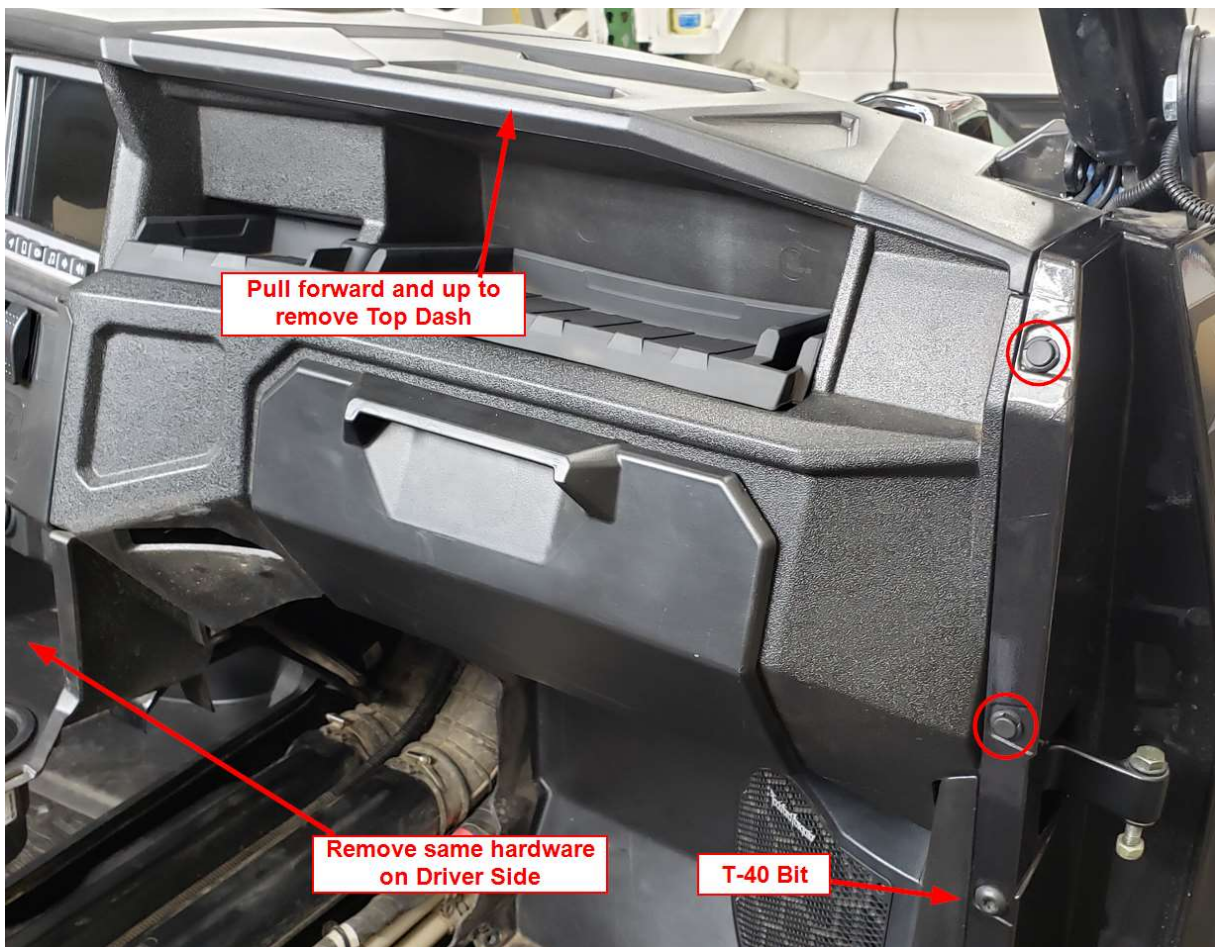

Figure 2

Polaris General with Fosgate Sub Ice Crusher Heater

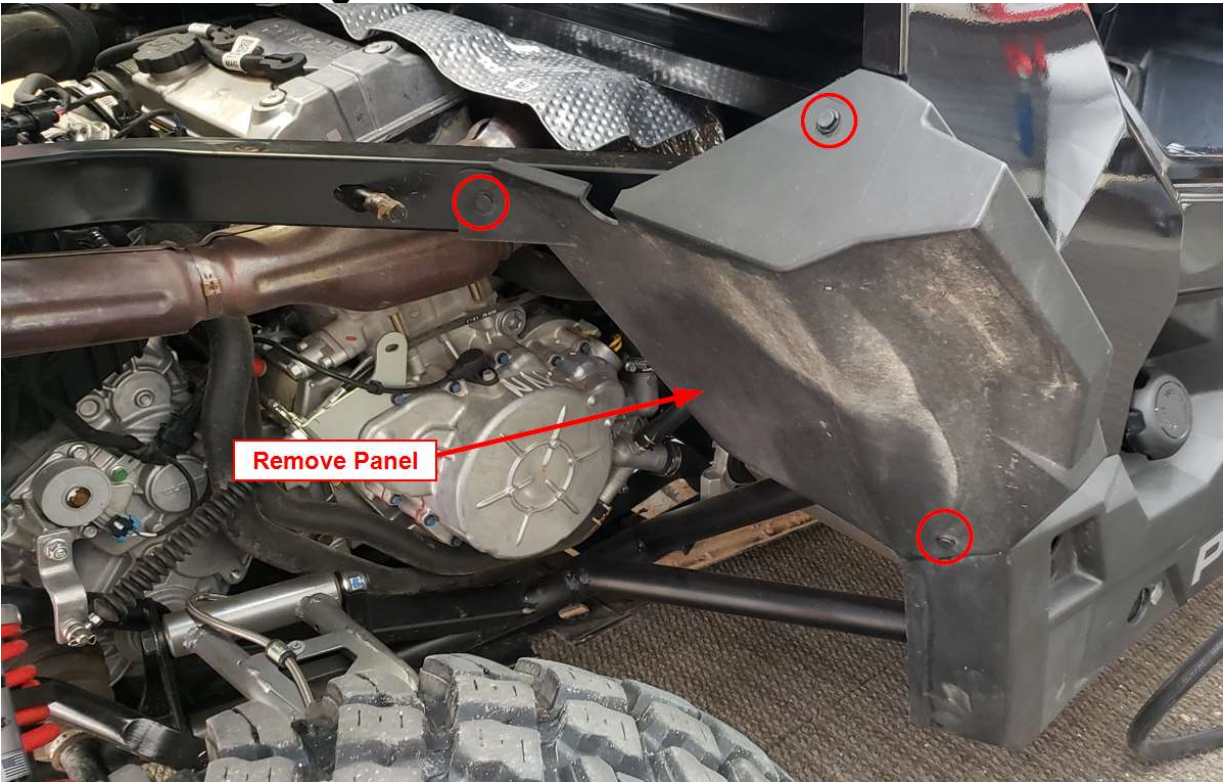

Figure 3



Figure 4

Polaris General with Fosgate Sub Ice Crusher Heater

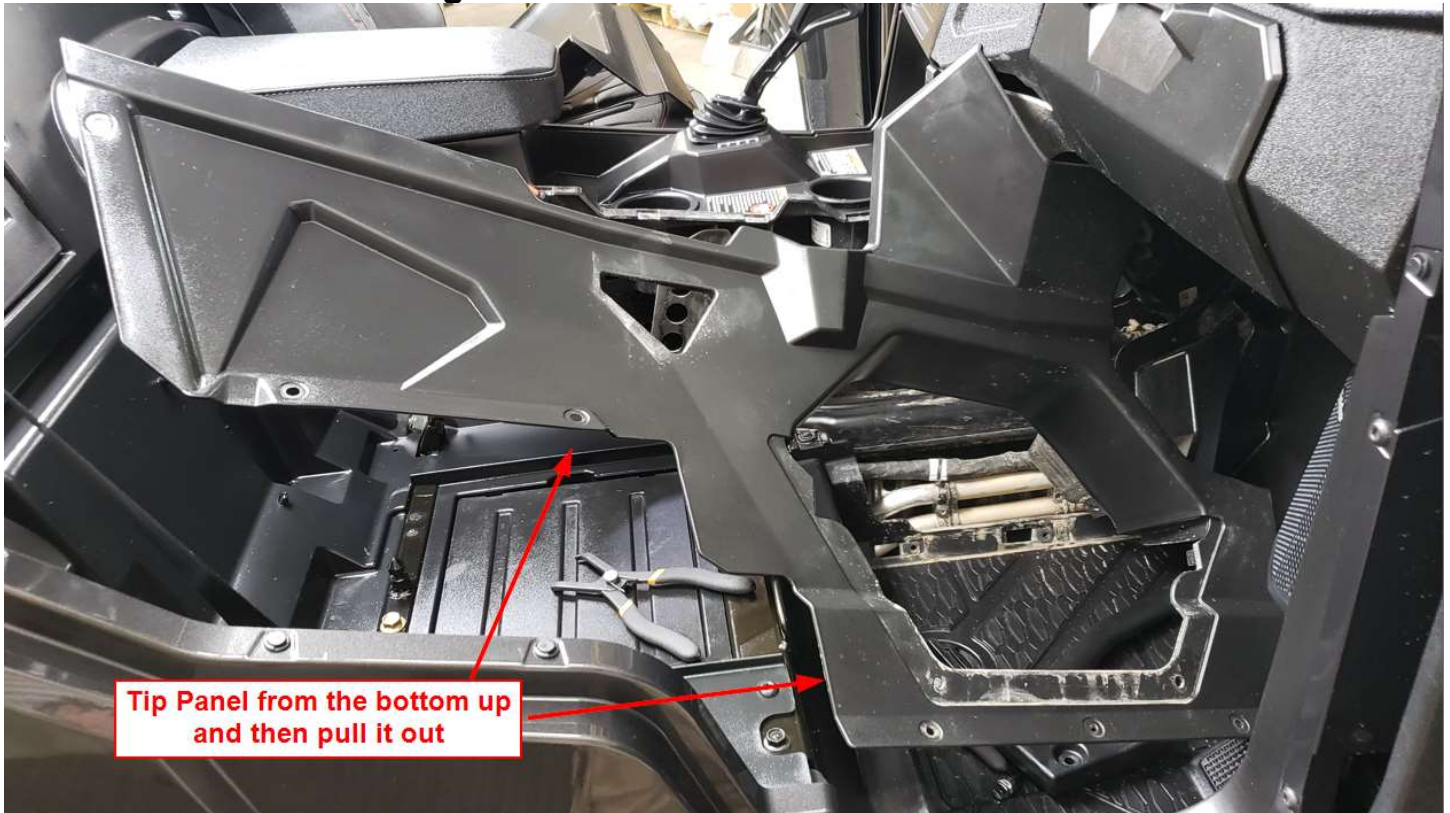

Figure 5

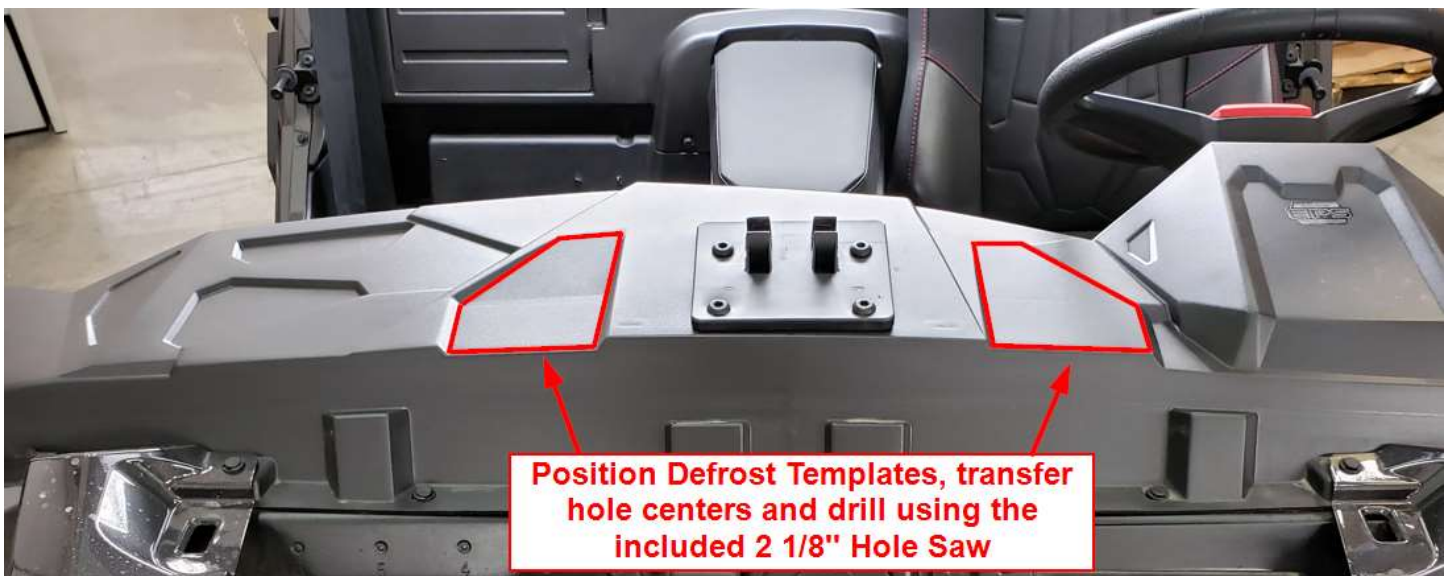

Figure 6

Polaris General with Fosgate Sub Ice Crusher Heater

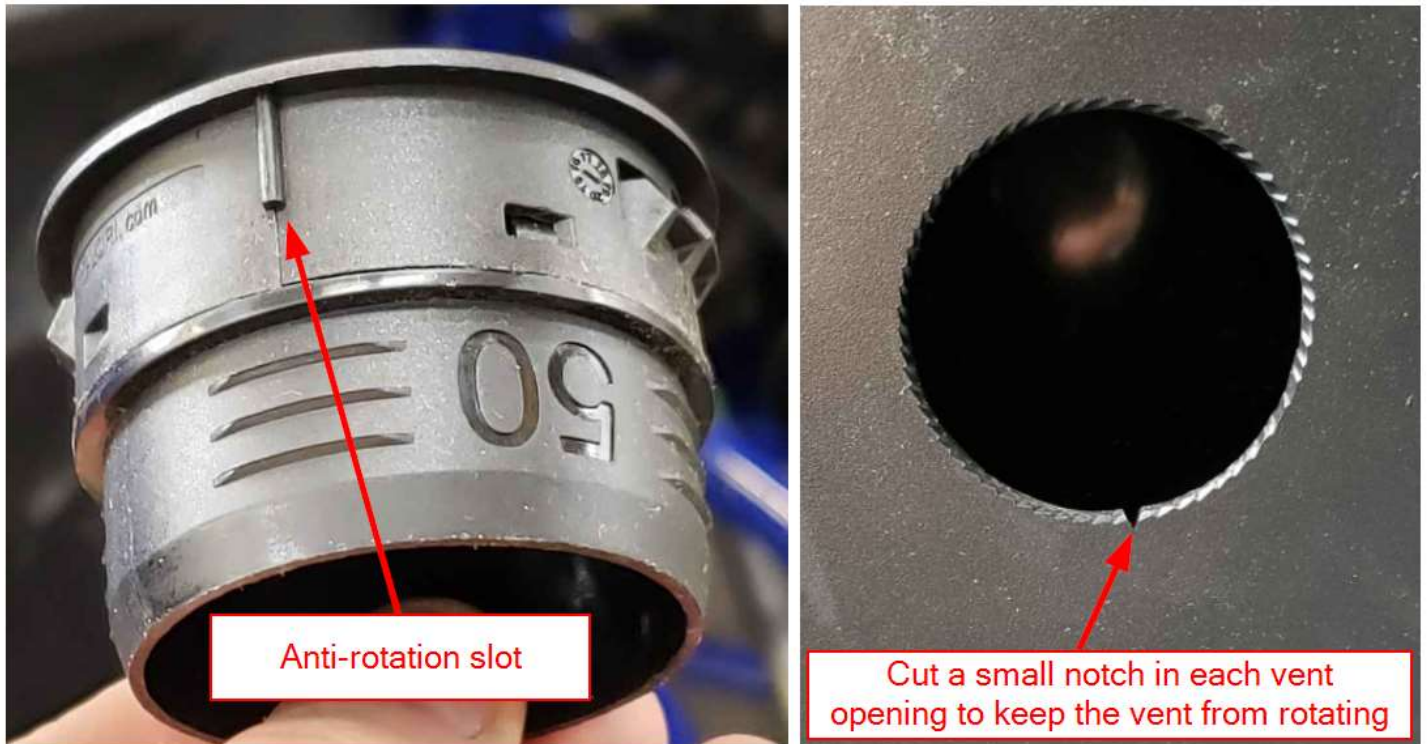

Figure 7

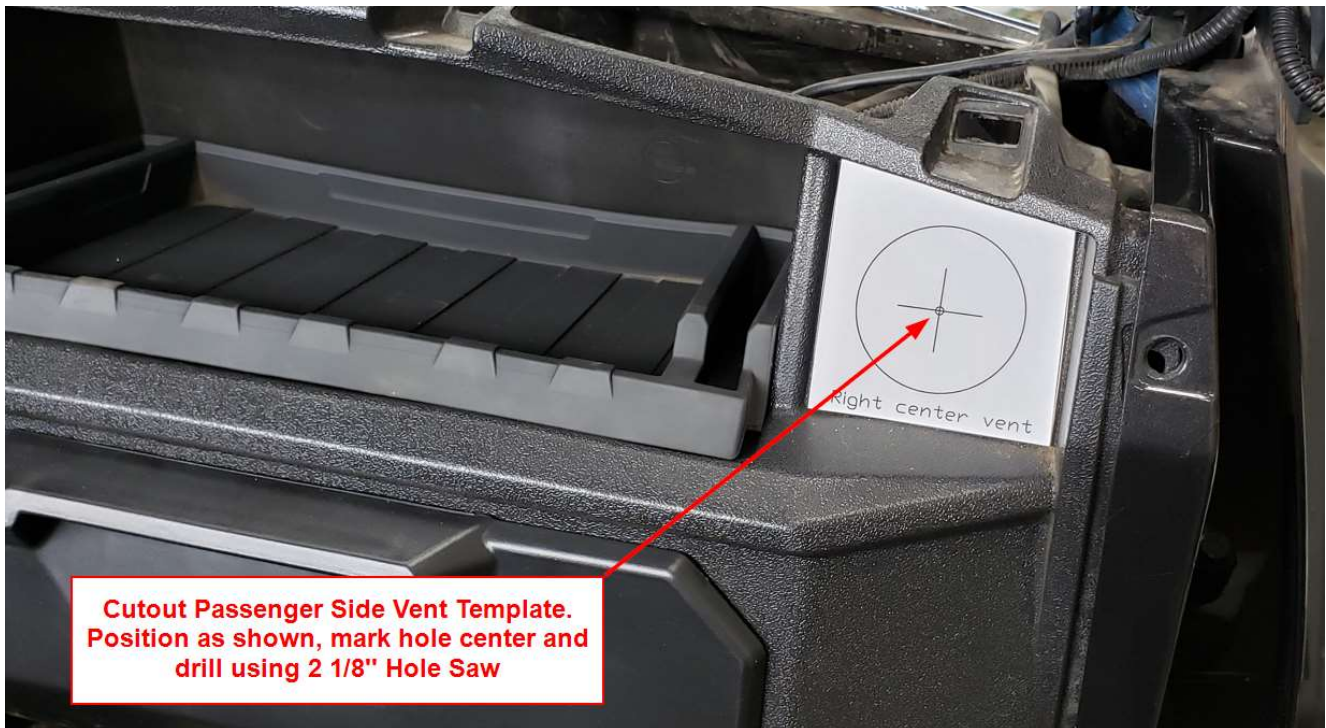

Figure 8

Polaris General with Fosgate Sub Ice Crusher Heater

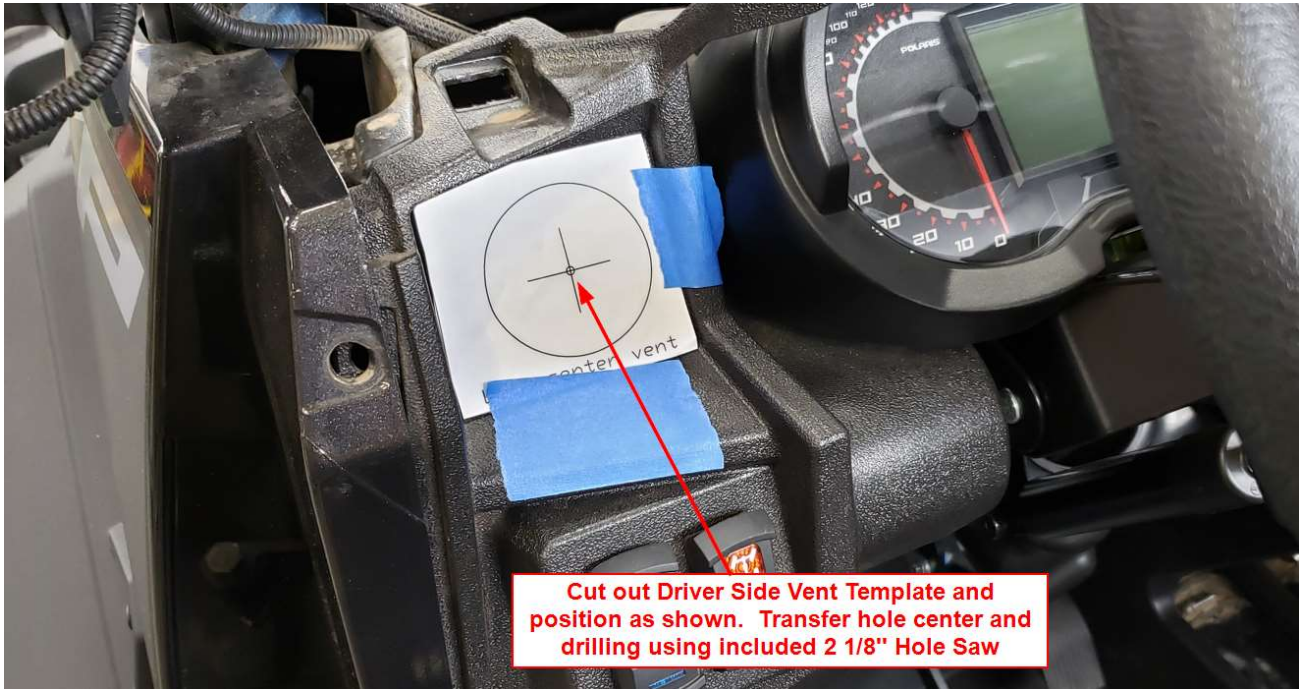

Figure 9

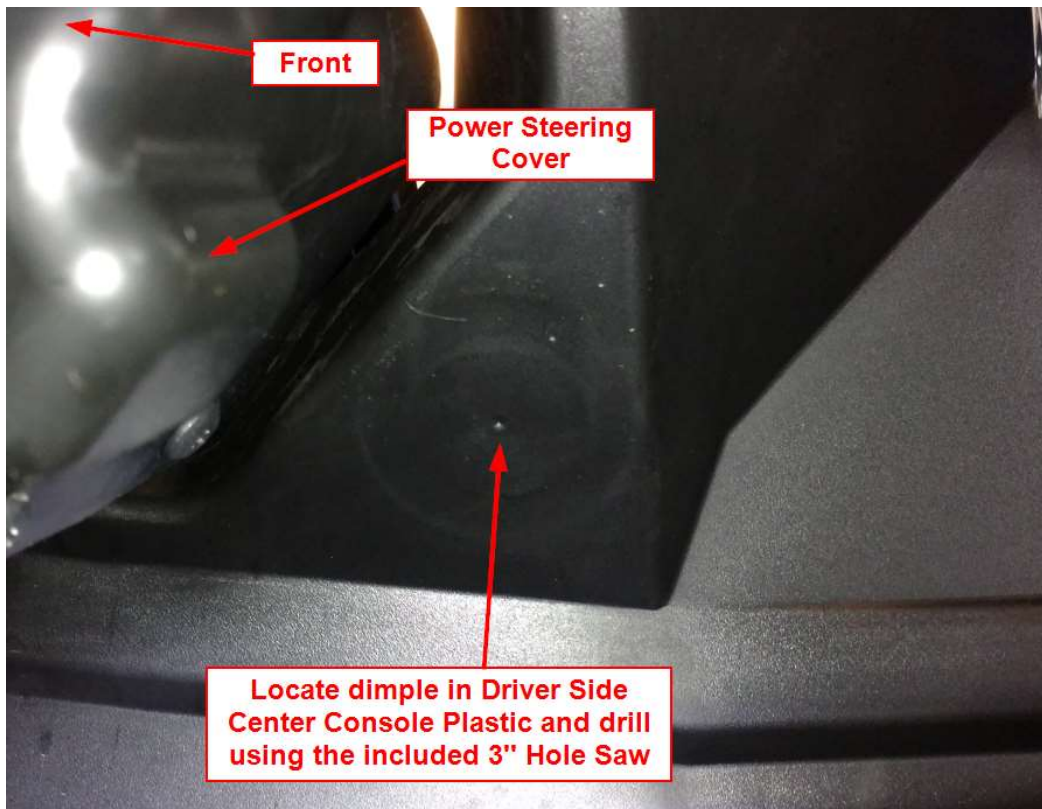

Figure 10

Polaris General with Fosgate Sub Ice Crusher Heater

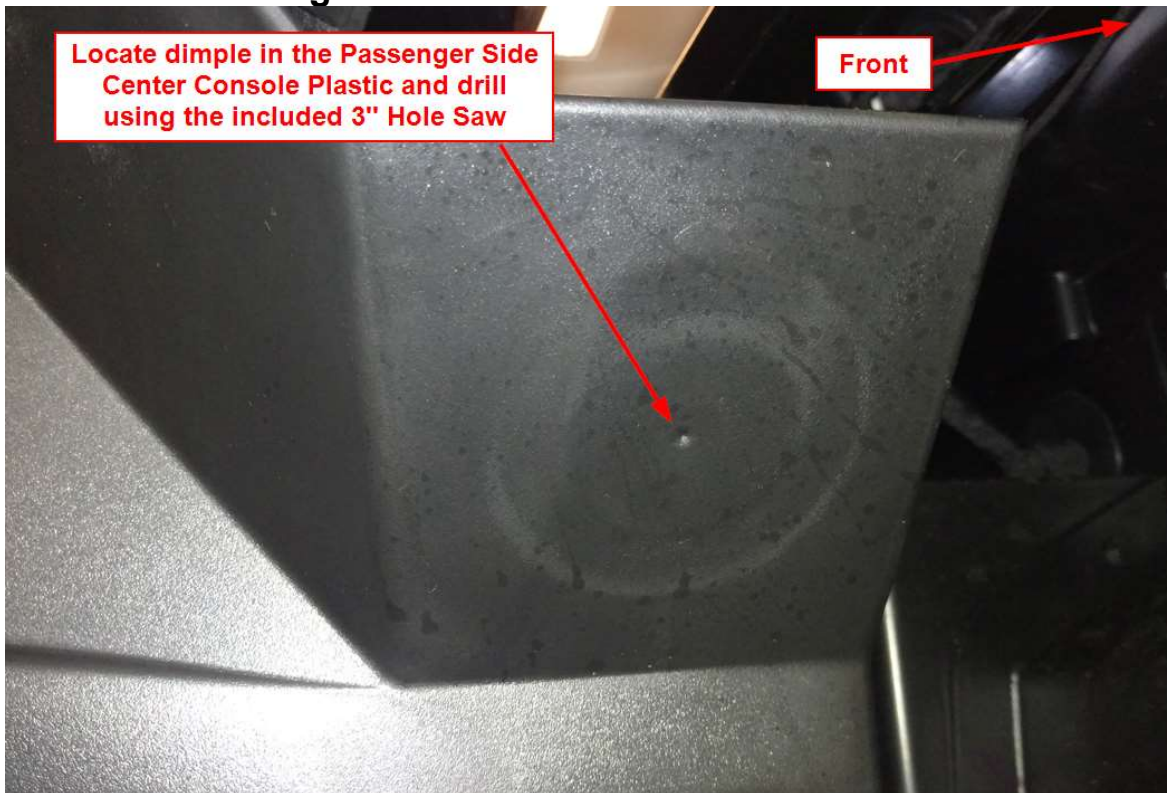

Figure 11

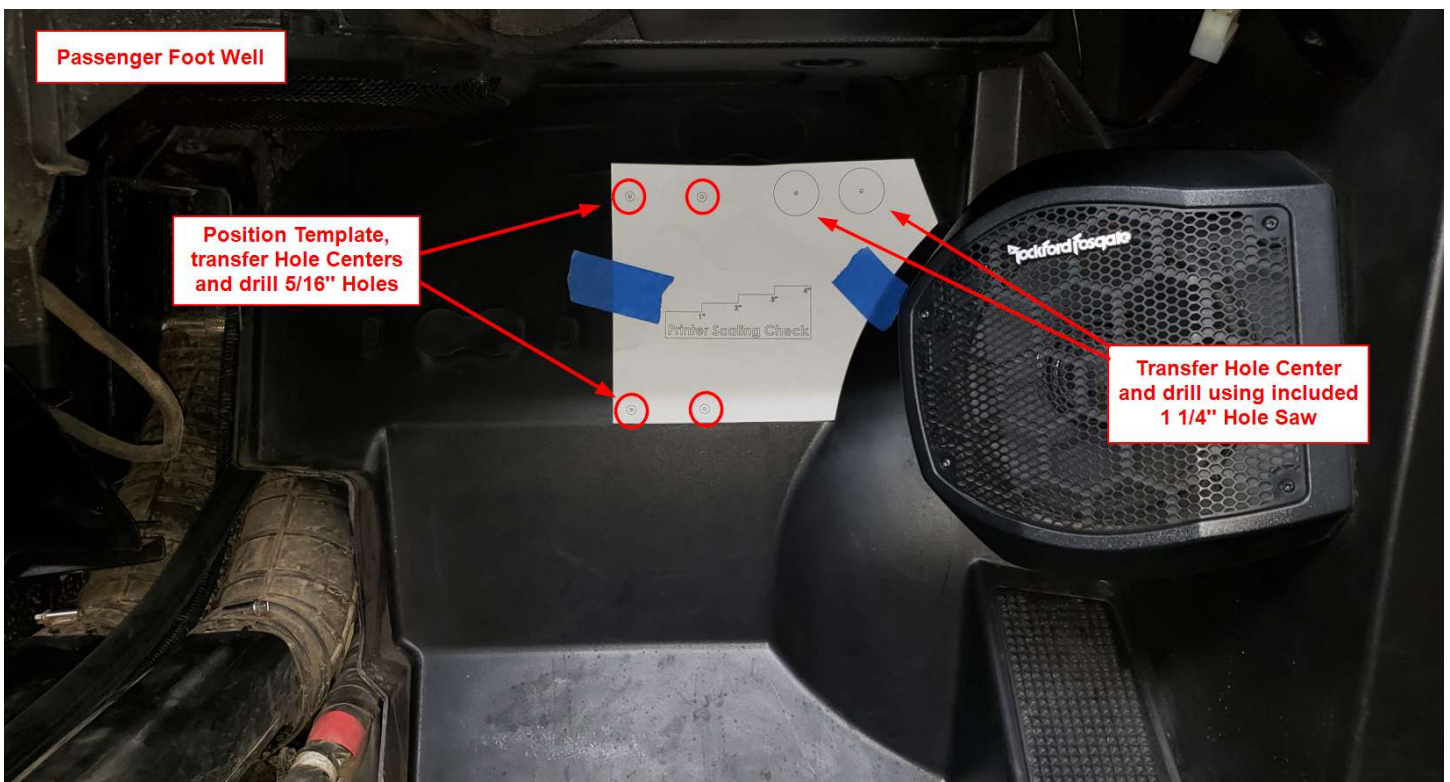

Figure 12

Polaris General with Fosgate Sub Ice Crusher Heater



Figure 13

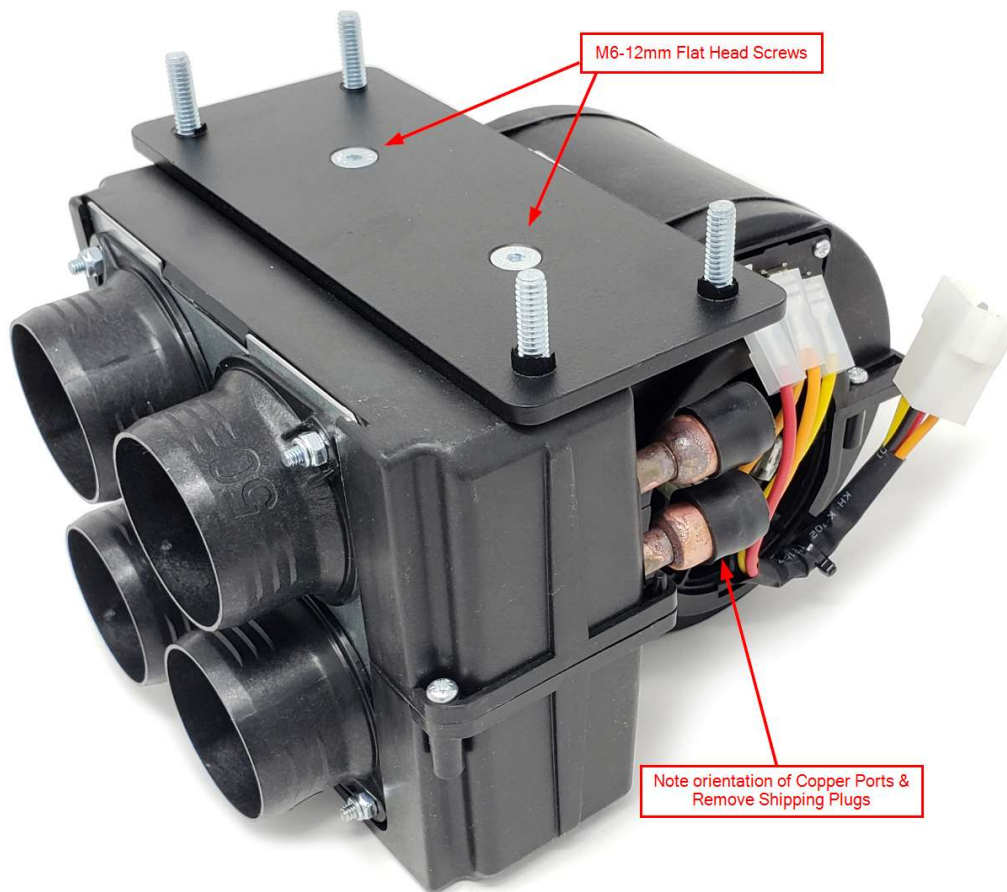

Figure 14

Polaris General with Fosgate Sub Ice Crusher Heater

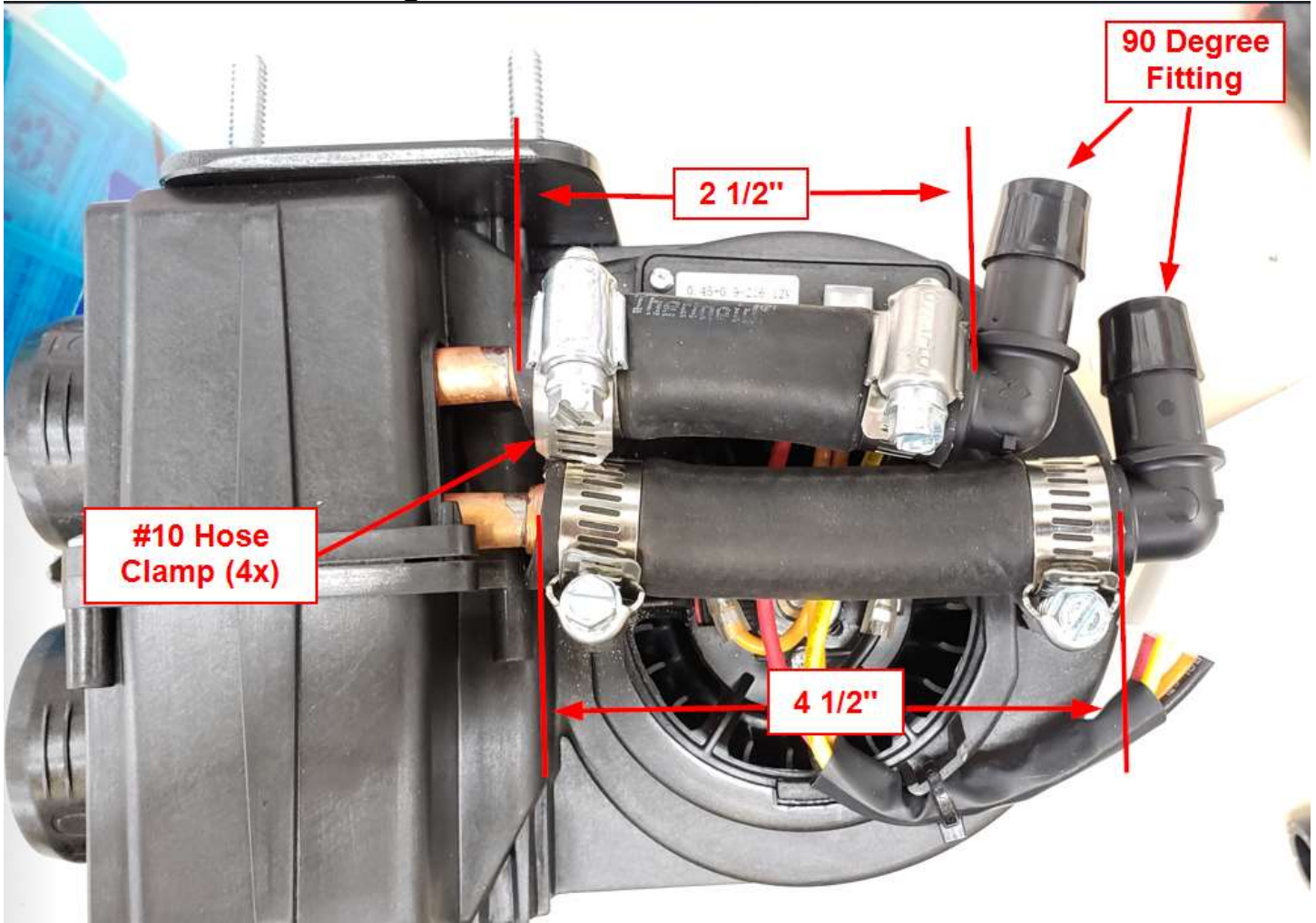

Figure 15

Polaris General with Fosgate Sub Ice Crusher Heater

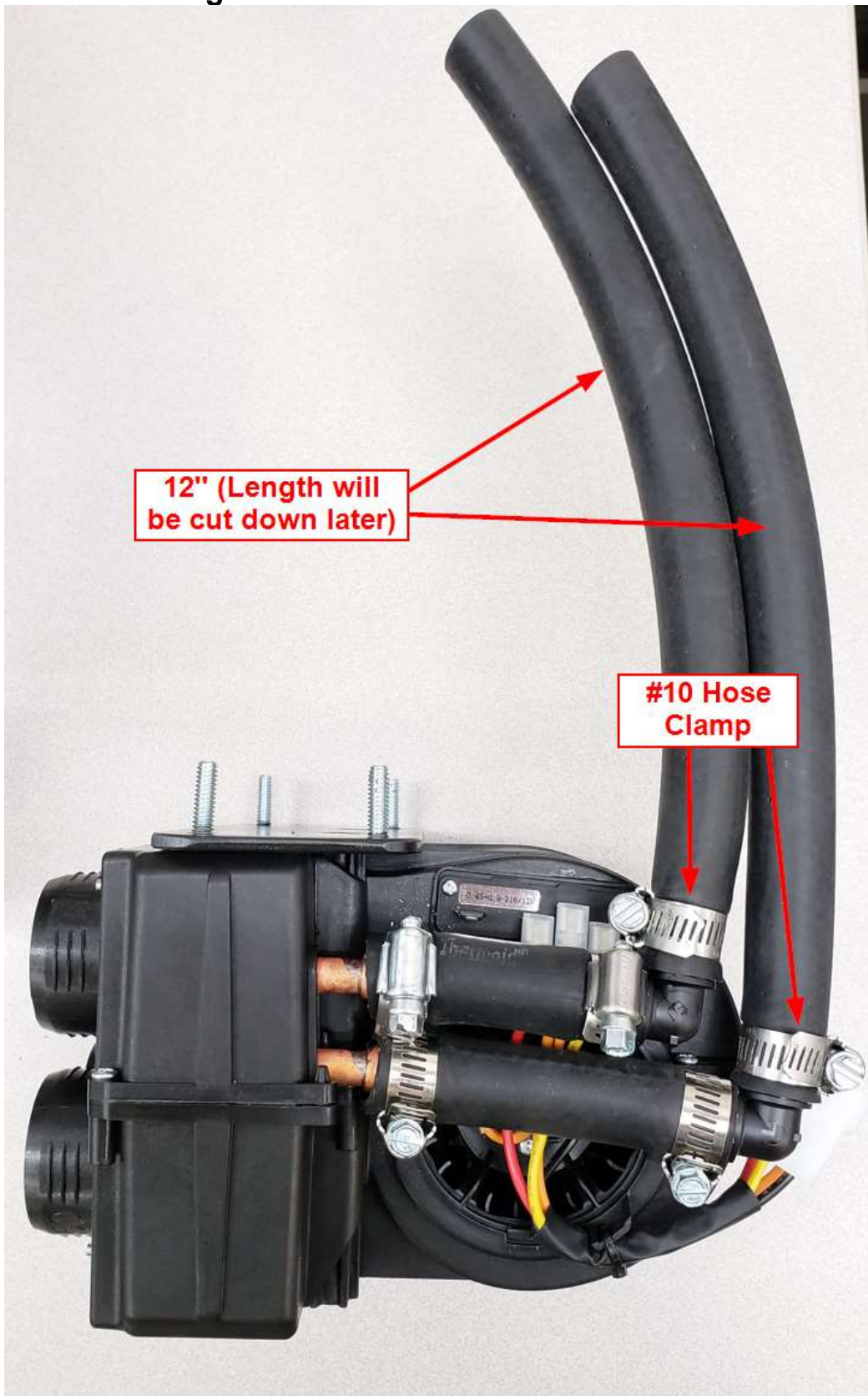

Figure 16

Polaris General with Fosgate Sub Ice Crusher Heater

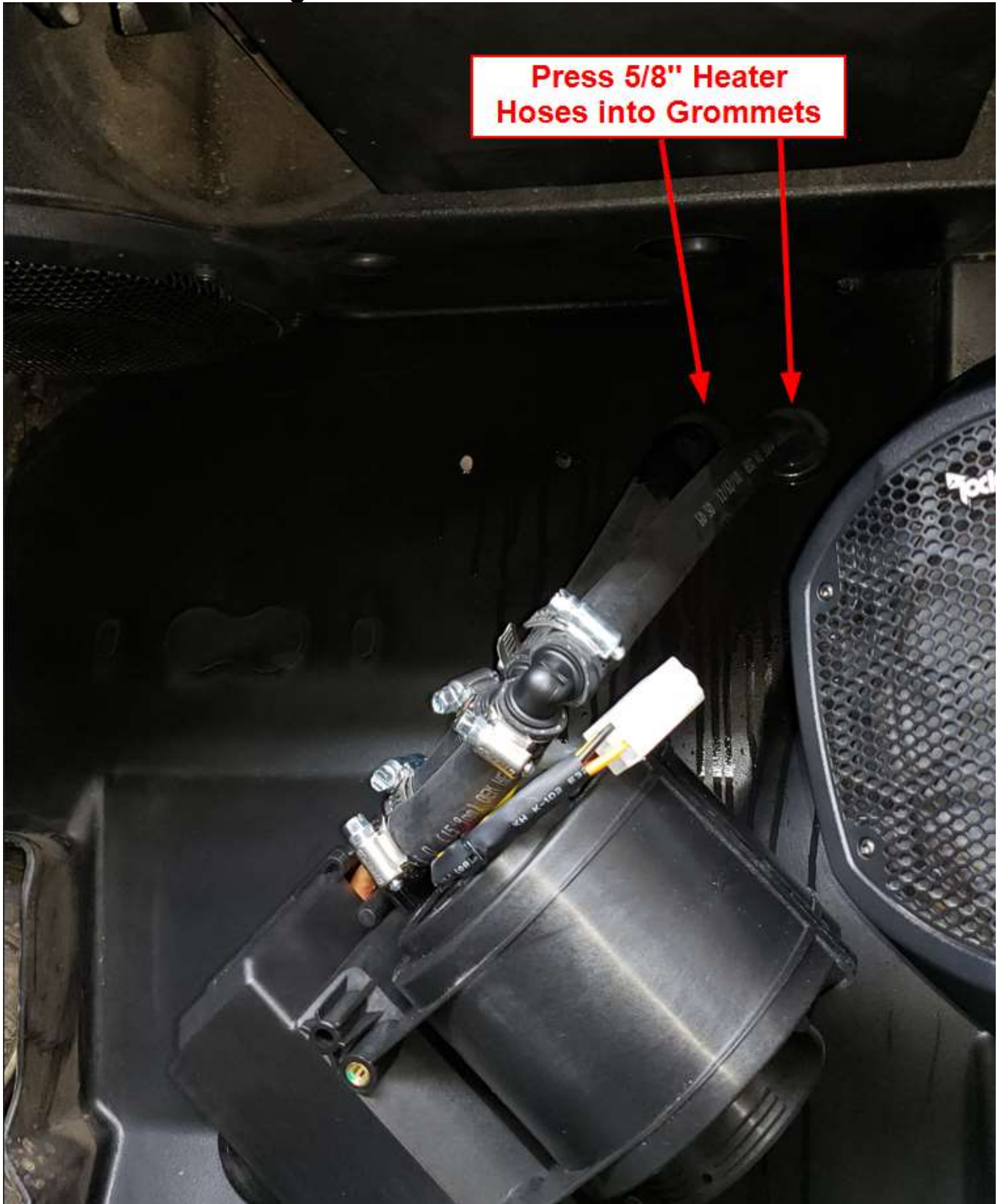

Figure 17

Polaris General with Fosgate Sub Ice Crusher Heater



Figure 18



Figure 19

Polaris General with Fosgate Sub Ice Crusher Heater

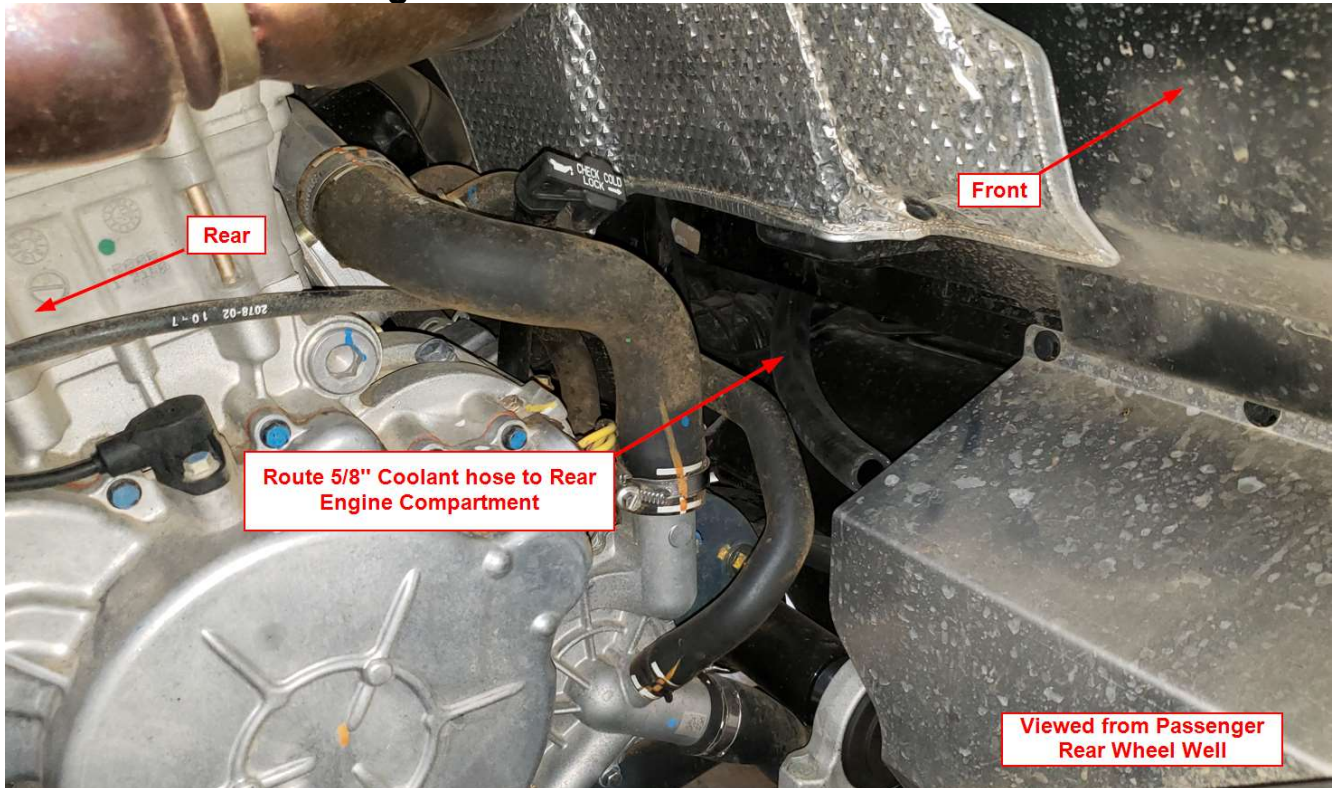

Figure 20

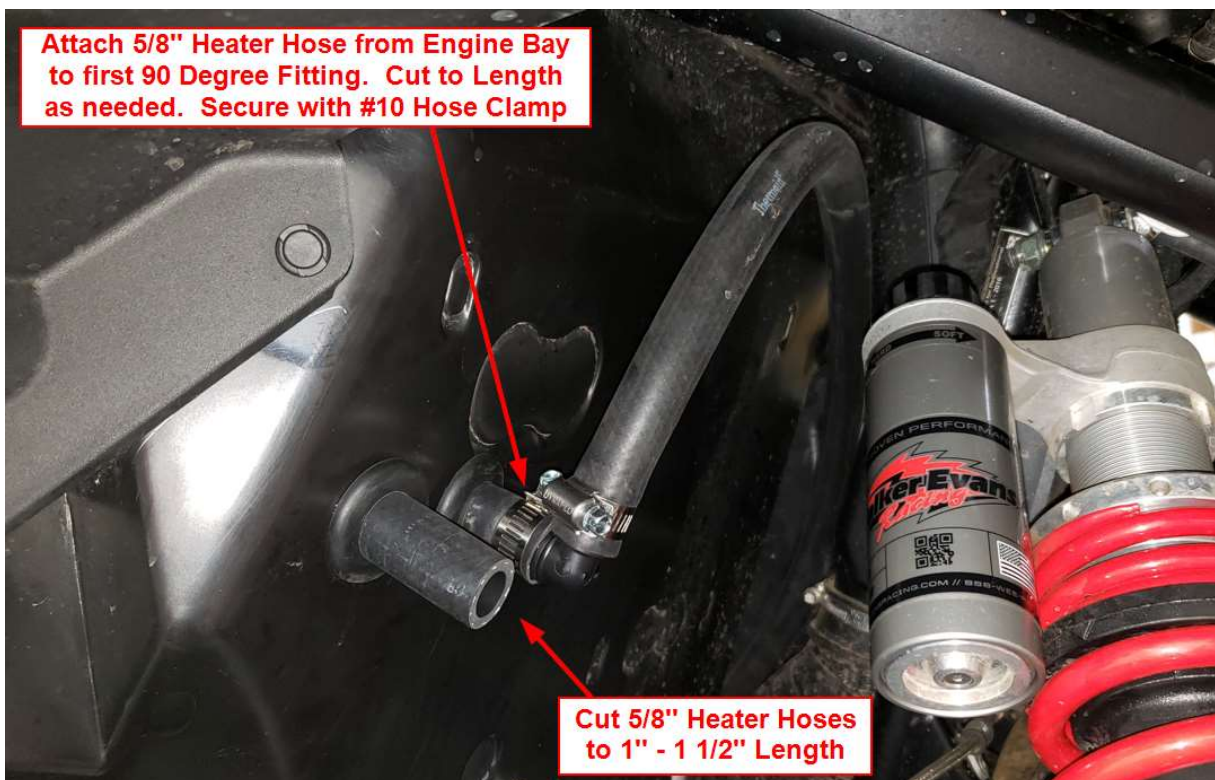

Figure 21

Polaris General with Fosgate Sub Ice Crusher Heater



Figure 22

Polaris General with Fosgate Sub Ice Crusher Heater

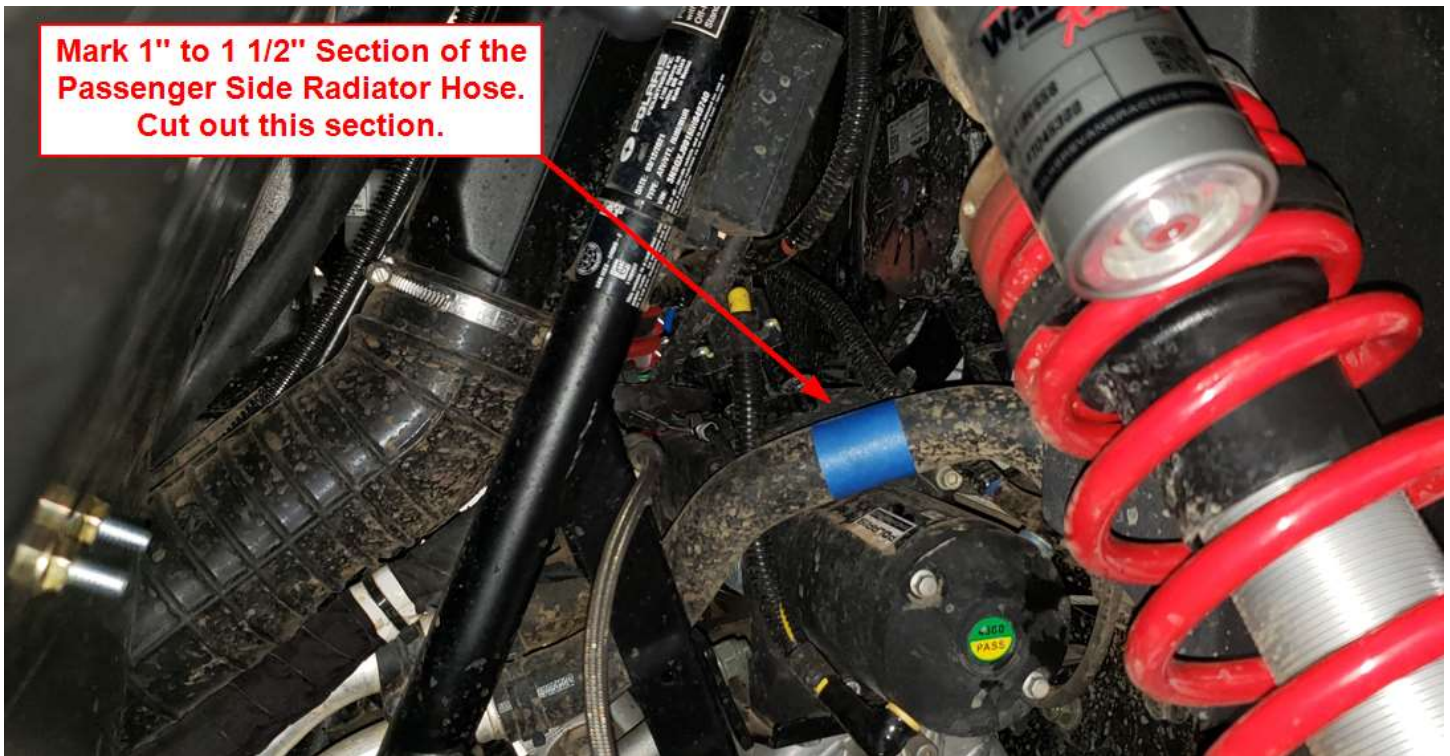

Figure 24

Polaris General with Fosgate Sub Ice Crusher Heater

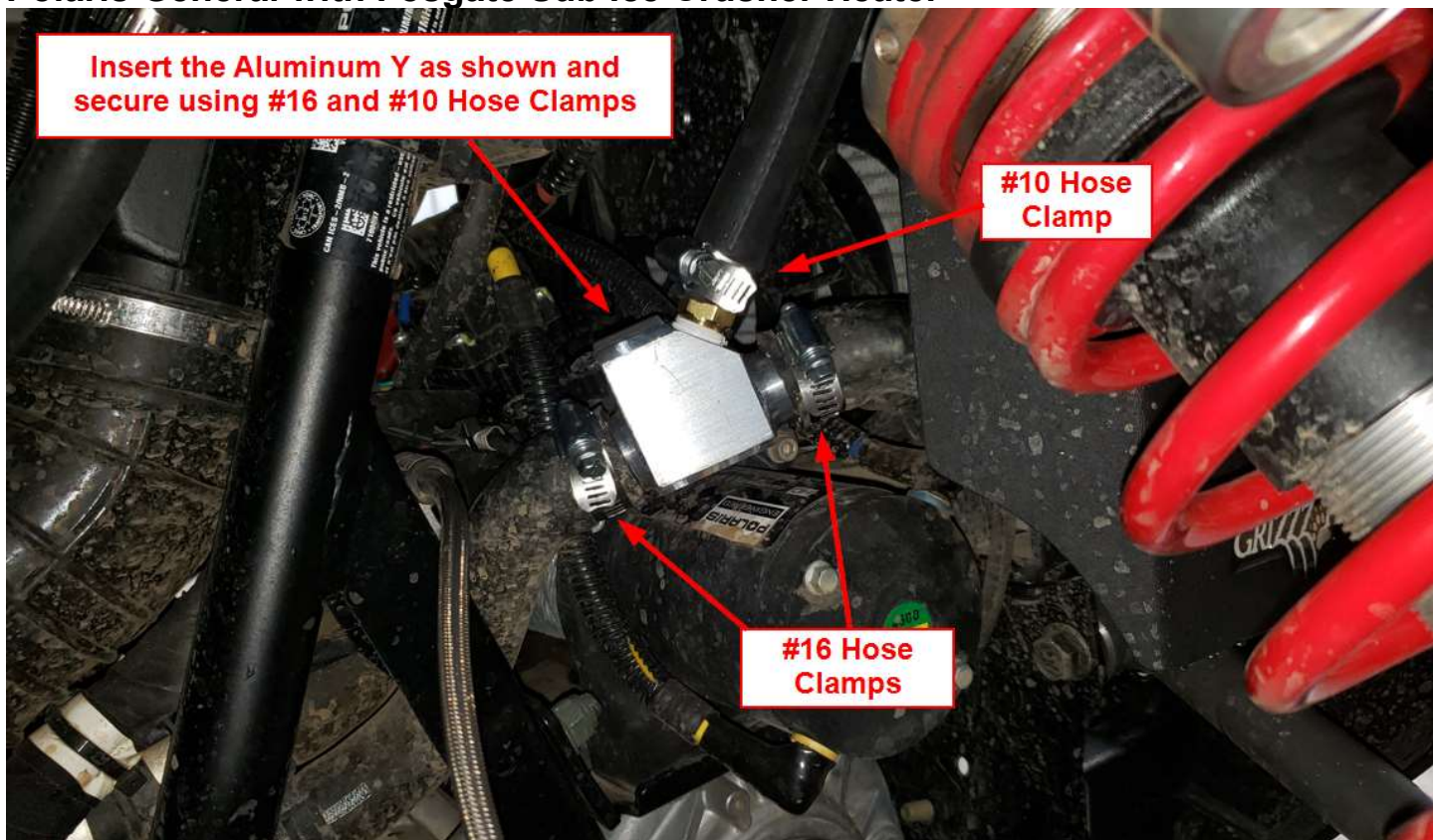

Figure 26

Polaris General with Fosgate Sub Ice Crusher Heater

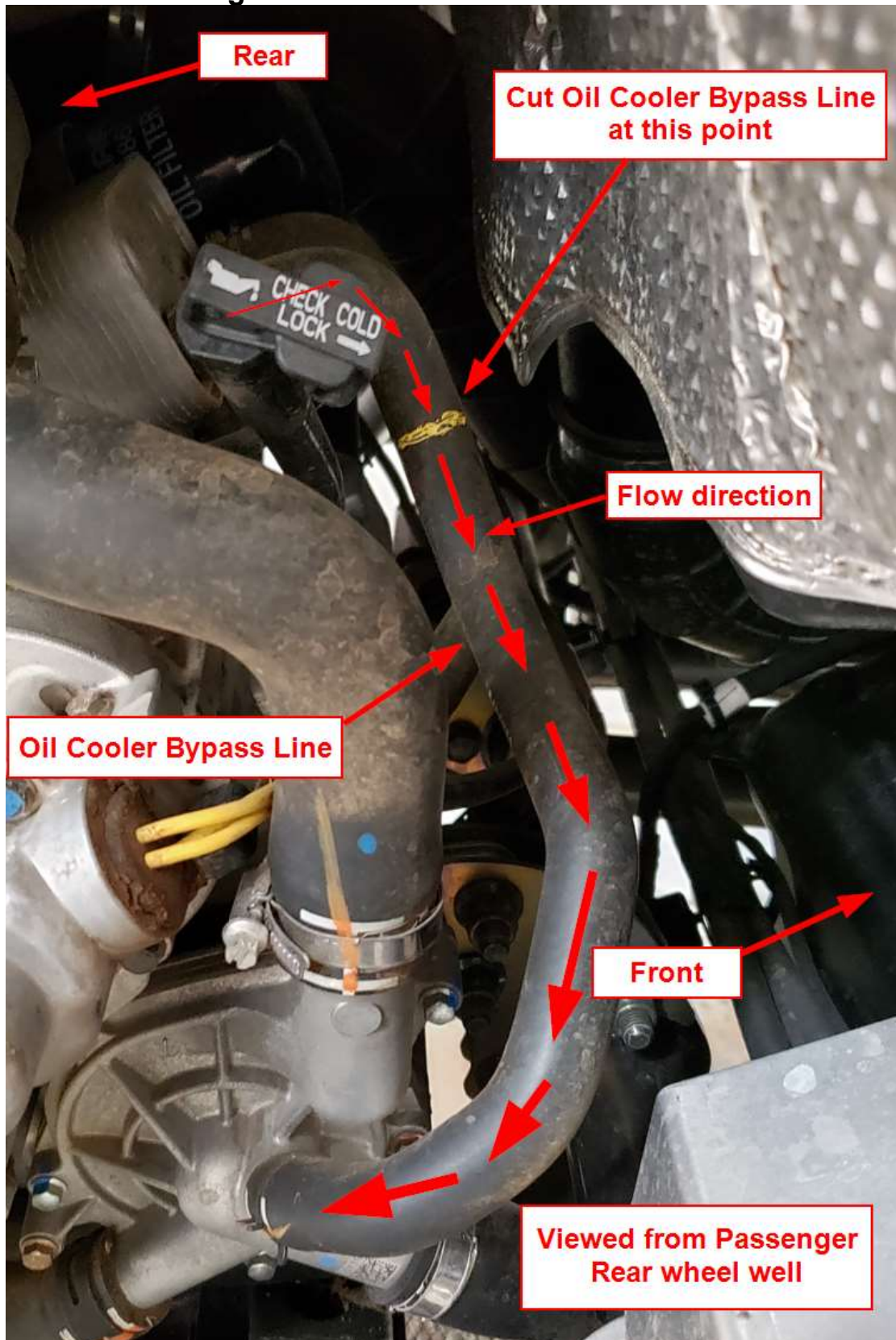

Figure 27

Polaris General with Fosgate Sub Ice Crusher Heater

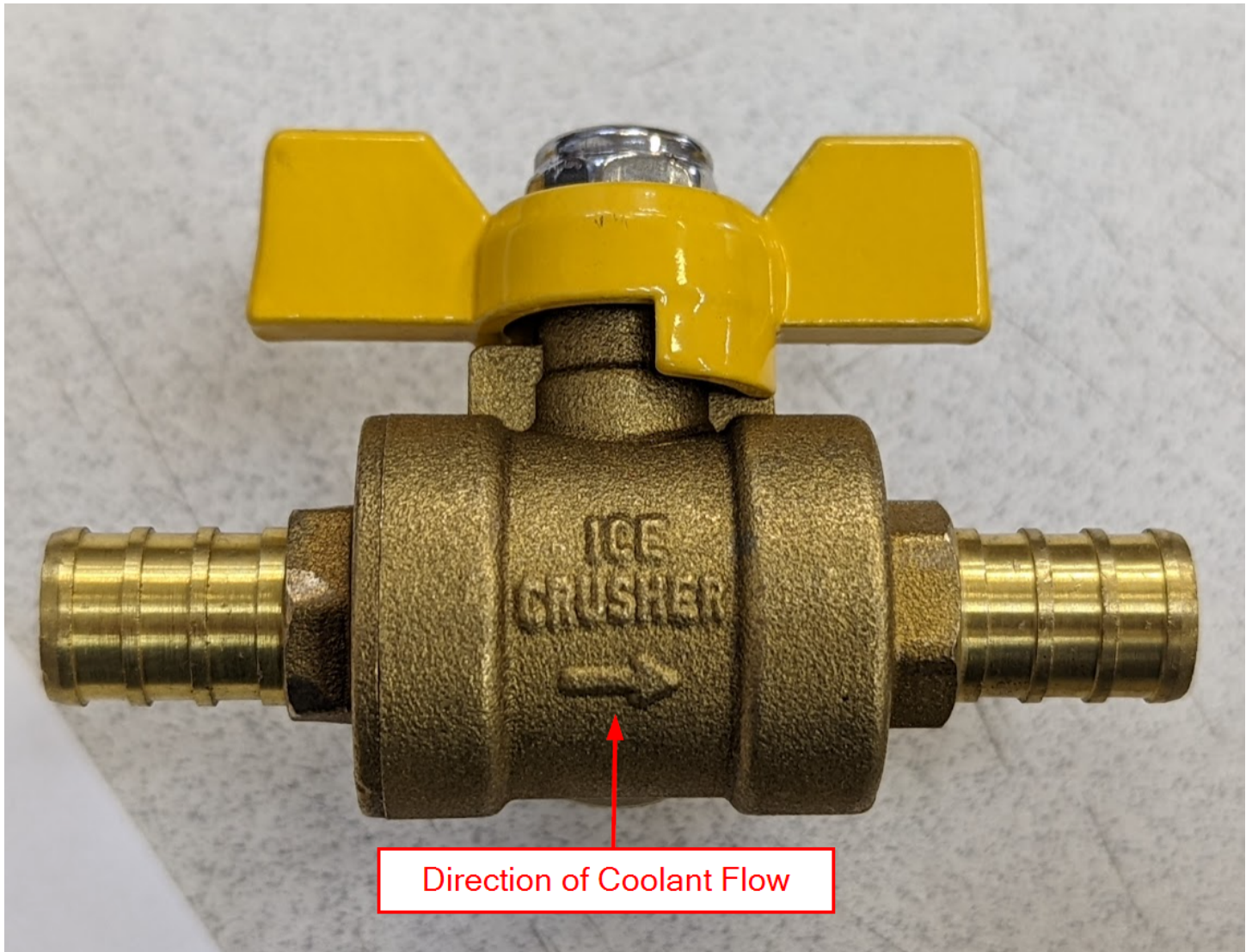

Figure 28

Polaris General with Fosgate Sub Ice Crusher Heater

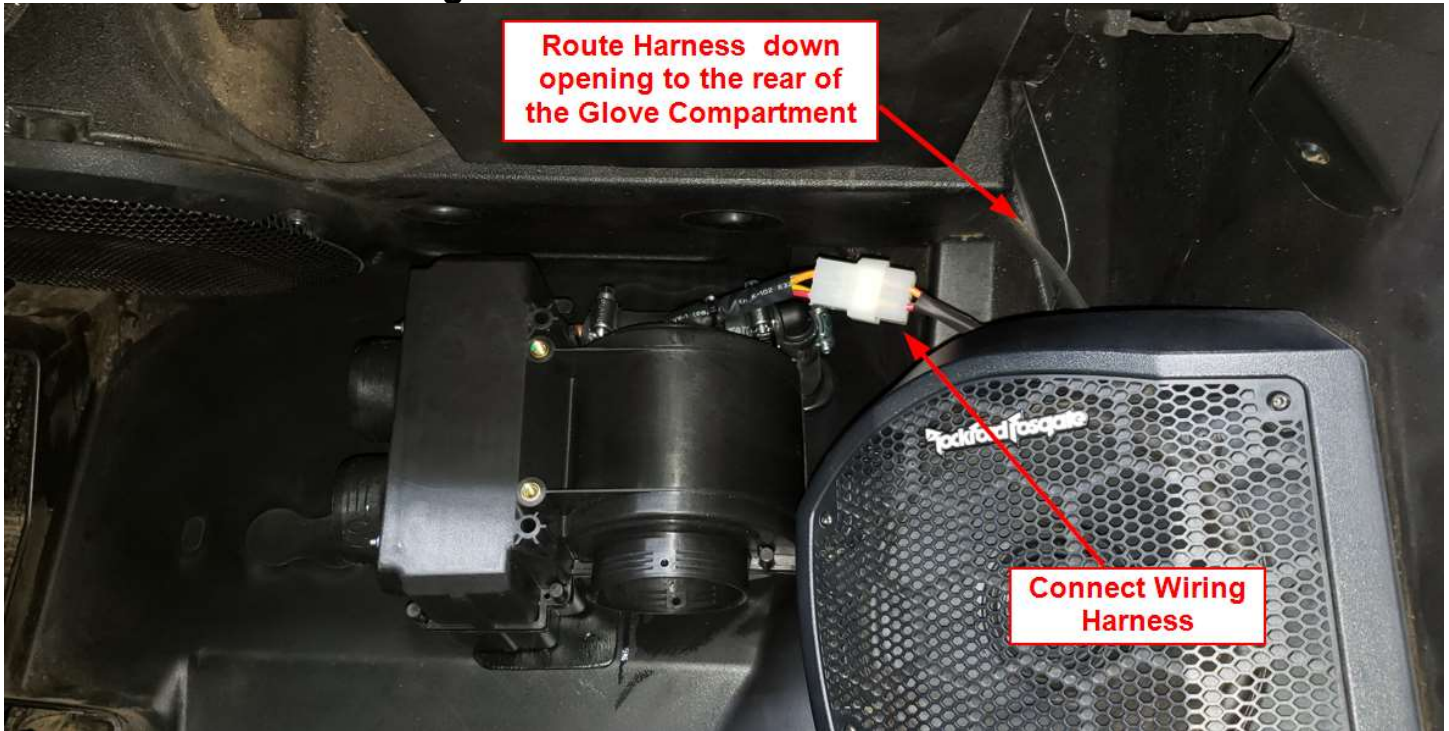

Figure 29



Figure 30

Polaris General with Fosgate Sub Ice Crusher Heater

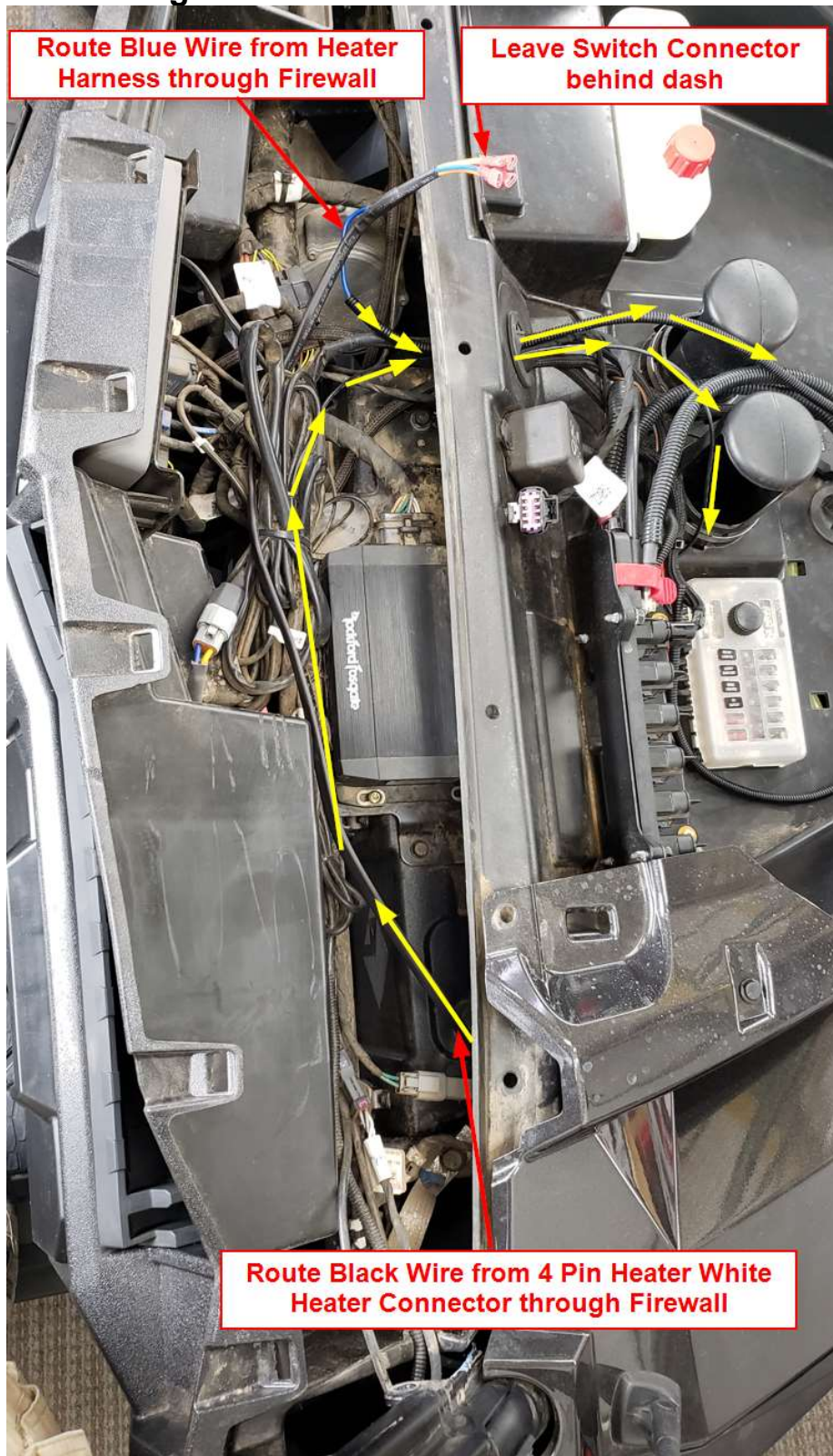

Figure 31

Polaris General with Fosgate Sub Ice Crusher Heater



Figure 32

Polaris General with Fosgate Sub Ice Crusher Heater

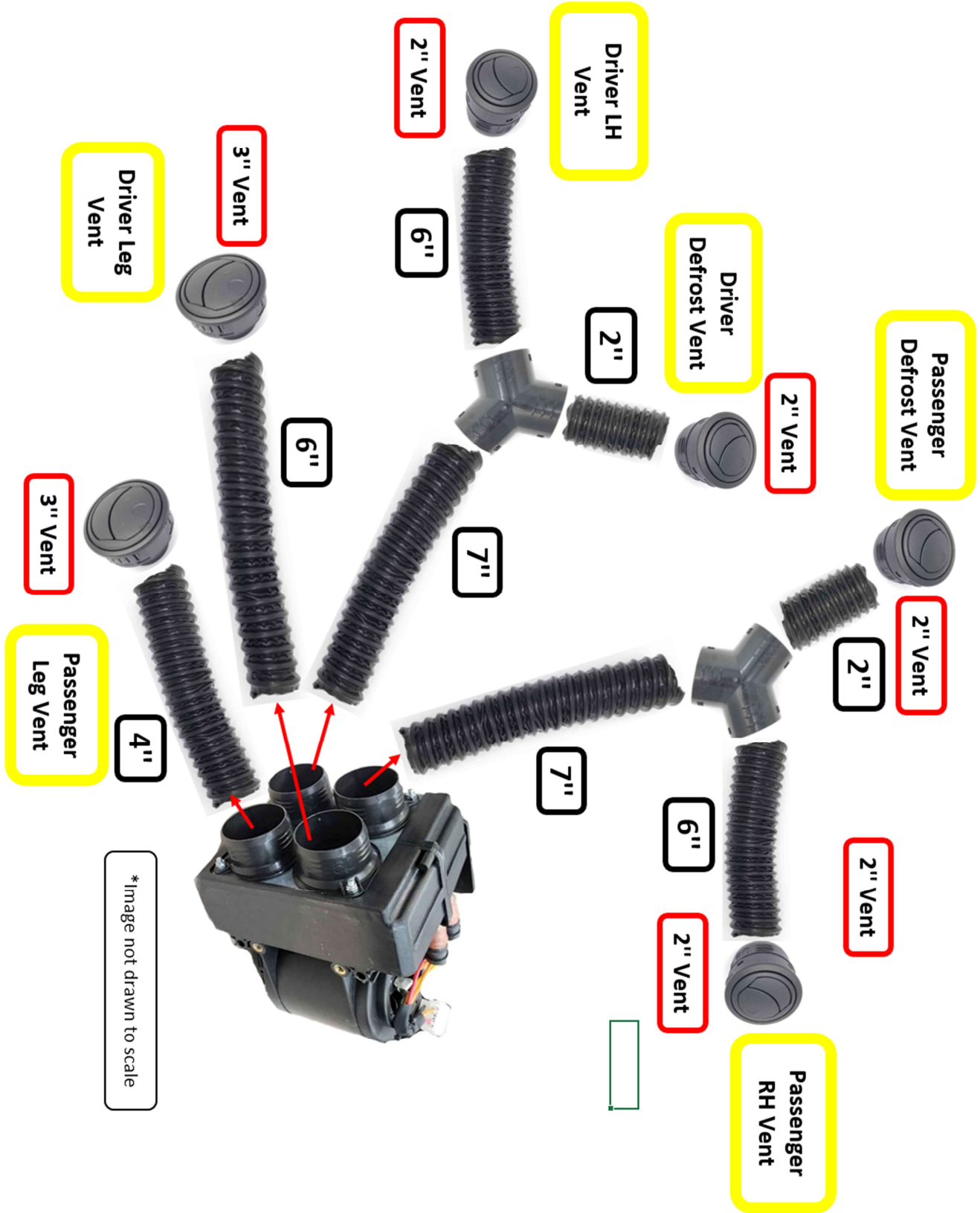

Figure 33

Polaris General with Fosgate Sub Ice Crusher Heater

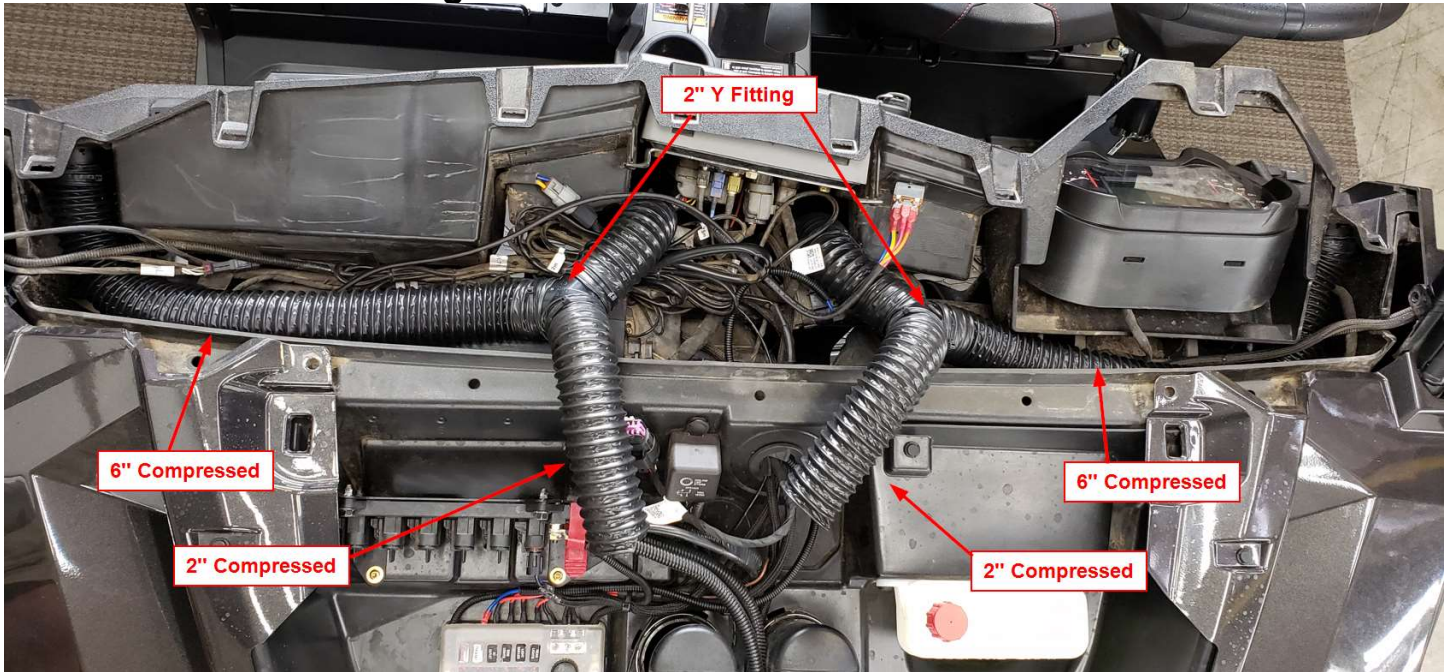

Figure 34

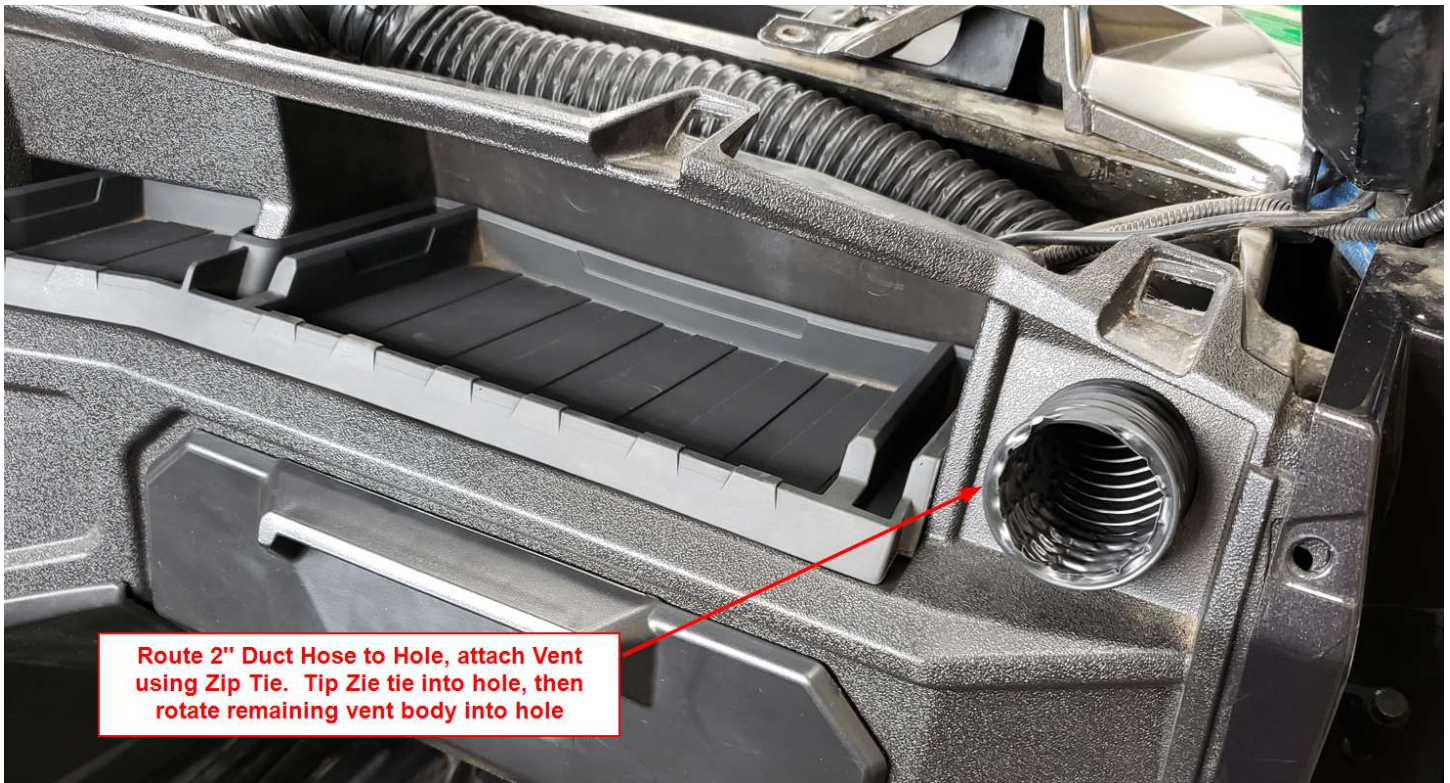

Figure 35

Polaris General with Fosgate Sub Ice Crusher Heater



Figure 36

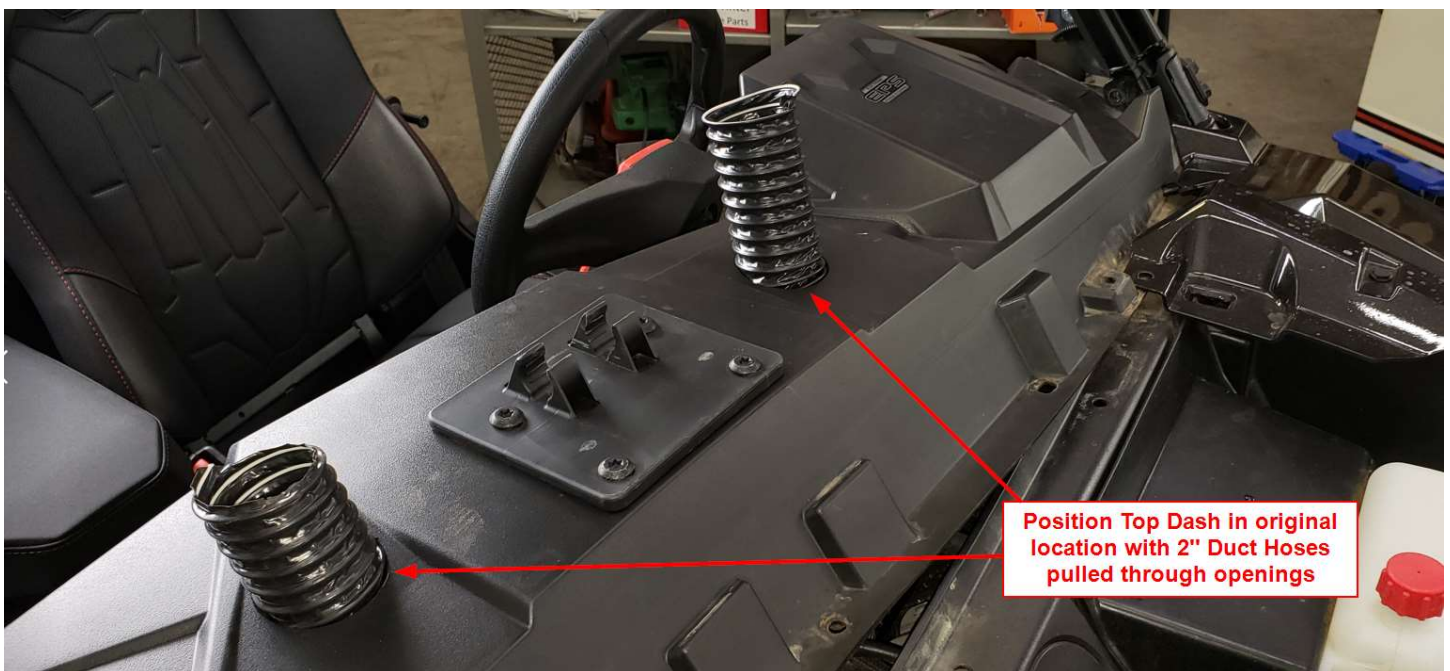

Figure 37

Polaris General with Fosgate Sub Ice Crusher Heater

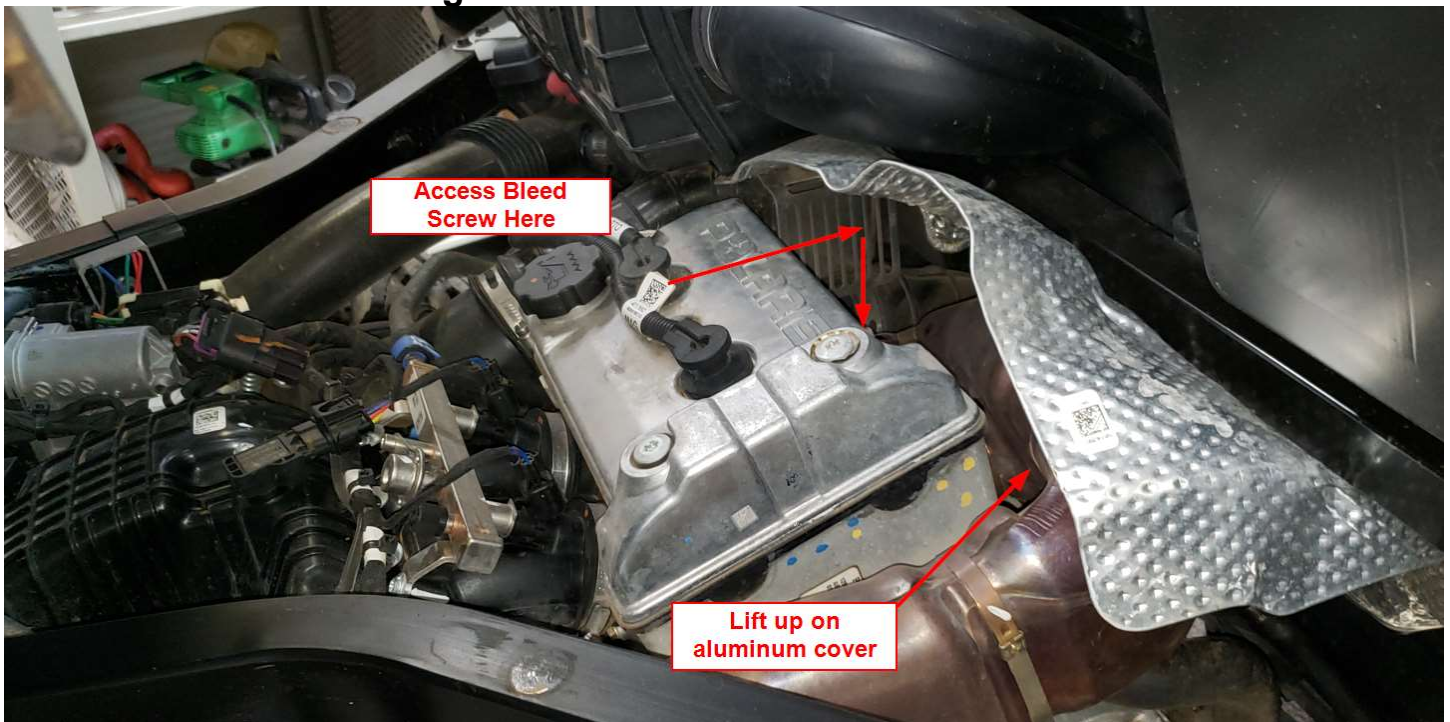

Figure 38

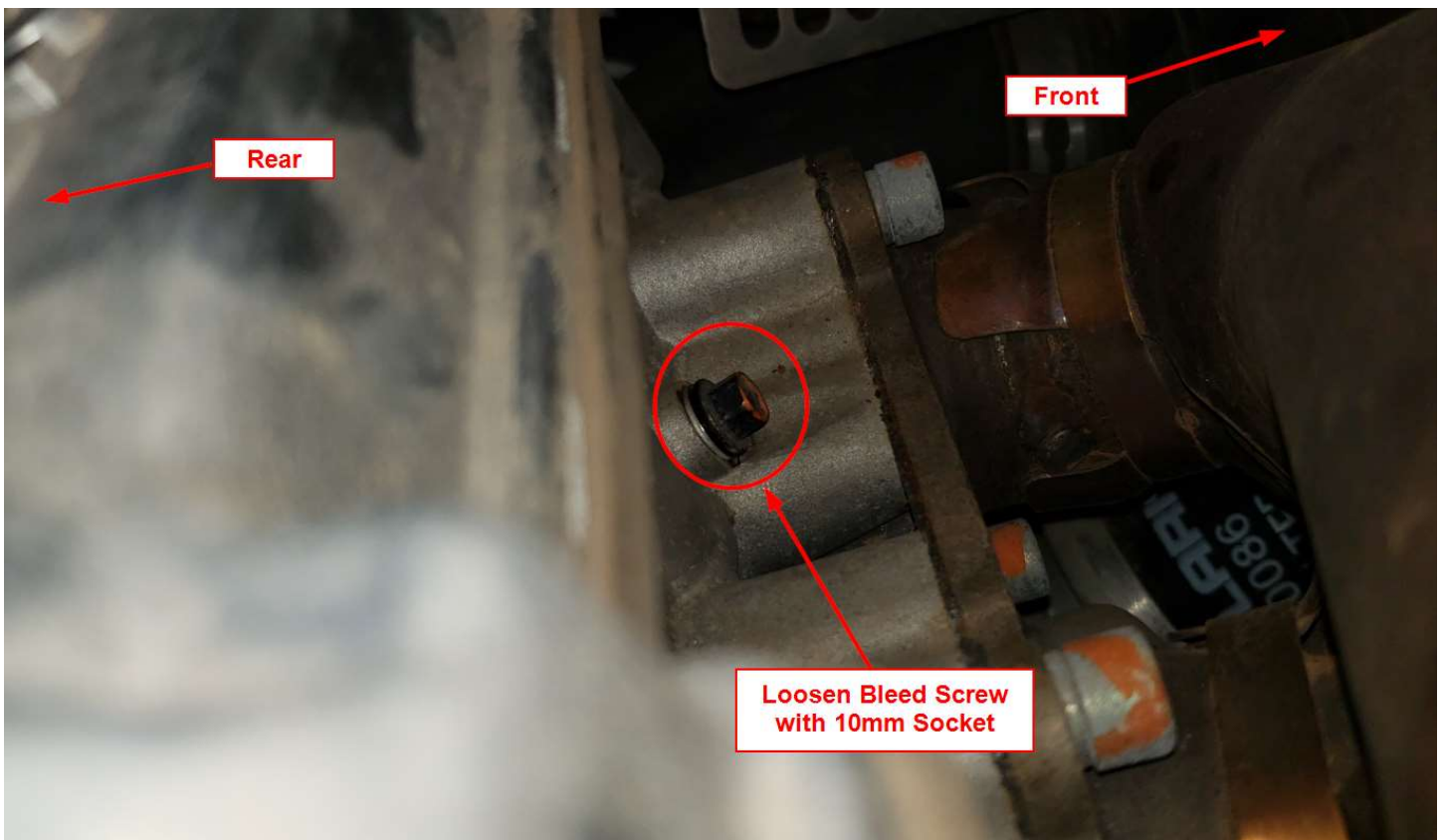

Figure 39

Polaris General with Fosgate Sub Ice Crusher Heater

HEATER WARRANTY – icecrusherheaters.com and coupersproducts.com

***Couplesproducts.com/Icecrusherheaters.com Heater Warranty. 3 Year/36 Month Limited Warranty**

Ice Crusher Heaters warrants your Ice Crusher UTV Heater System to be free from defects in material and craftsmanship under normal use and service by the original consumer purchaser (end user) for a period of Three (3) year from the date of purchase on all components including electrical components. The warranty is null and void if the system has been damaged by accident, improper installation, unreasonable use, lack of proper maintenance, unauthorized repairs or modifications, or causes not arising from defects in materials and craftsmanship.

Ice Crusher Heaters obligation under this warranty are limited to repair of the product at Ice Crusher Heaters production facility, or the replacement of the product at Ice Crusher Heaters option and at Ice Crusher Heaters expense. Any expense involved *in the removal, reinstallation, or transportation of the product is **not** covered by this warranty*. Prior to return of any product to Ice Crusher Heaters, customer must contact Ice Crusher Heaters customer service, (888)-964-0135, info@utvheaters.com, and obtain a Return Authorization Number. This number must be marked on exterior of carton for easy identification. Warranty product received at Ice Crusher Heaters without a Return Authorization Number may be returned at expense of sender.

Postage must be prepaid, and the original dated proof-of-purchase must be confirmed or provided. Ice Crusher Heaters will not be liable for any damages sustained in transport due to improper packaging or handling. The acceptance by UTV HEATER WARRANTY – utvheaters.com and coupersproducts.com

This warranty is Couper's Products only express warranty of this product. We reserve the right to make changes to products and policy that are in the best interest of Couper's Products. No implied warranty shall extend beyond One (1) or Three (3) year period from the date of the original consumer (end user) purchase. Couper's Products will not be liable for any damages, for loss of use of this product, nor for any consequential damages, costs or expenses.

Some states do not allow limitations on how long an implied warranty lasts or the exclusion of incidental or consequential damages, so the above limitations and exclusions may not apply to you. This warranty gives you specific legal rights and you may also have other rights not mentioned here that vary from state to state.

After receiving a Return Authorization Number send defective product to:

Ice Crusher Heaters

Attn: Warranty

23001 Industrial Blvd

Rogers, Minnesota, 55374

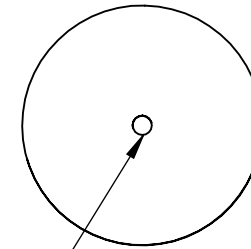
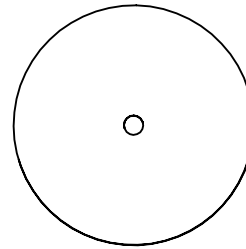

1/4" Drill Bit

1 1/4" Hole Saw

Firewall Template

Cut out template and place on Passenger Side Firewall as shown in the instructions. Transfer all six hole centers to the firewall and drill using a 1 1/4" Hole Saw and 1/4" Drill Bit

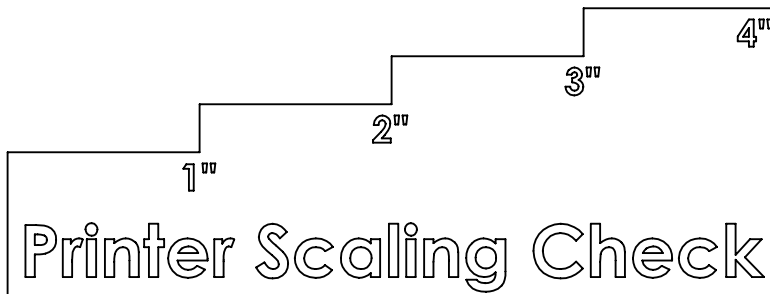

Switch

Control Template

Mark hole center and drill holes
as stated

Fan Switch

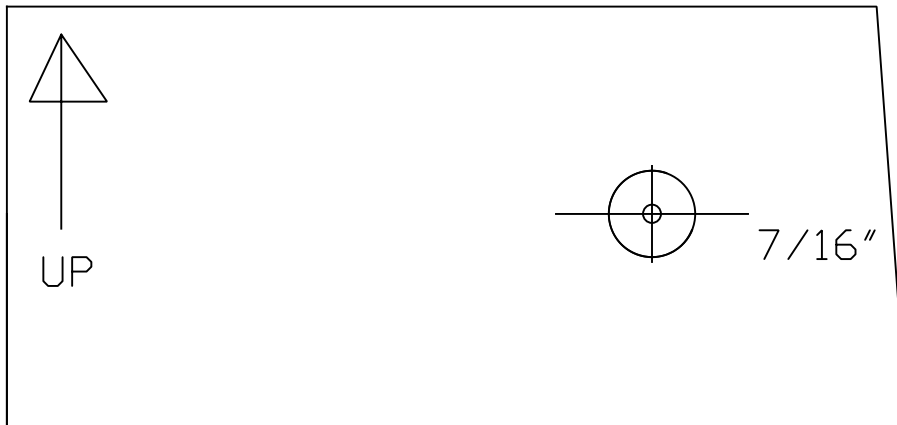

Align edges with panel moulding

Please note: Before drilling any holes check area behind firewall/dash panels to make sure no damage or interference with equipment will occur by drilling holes and fitting of vents.

Right Defrost Vent Template

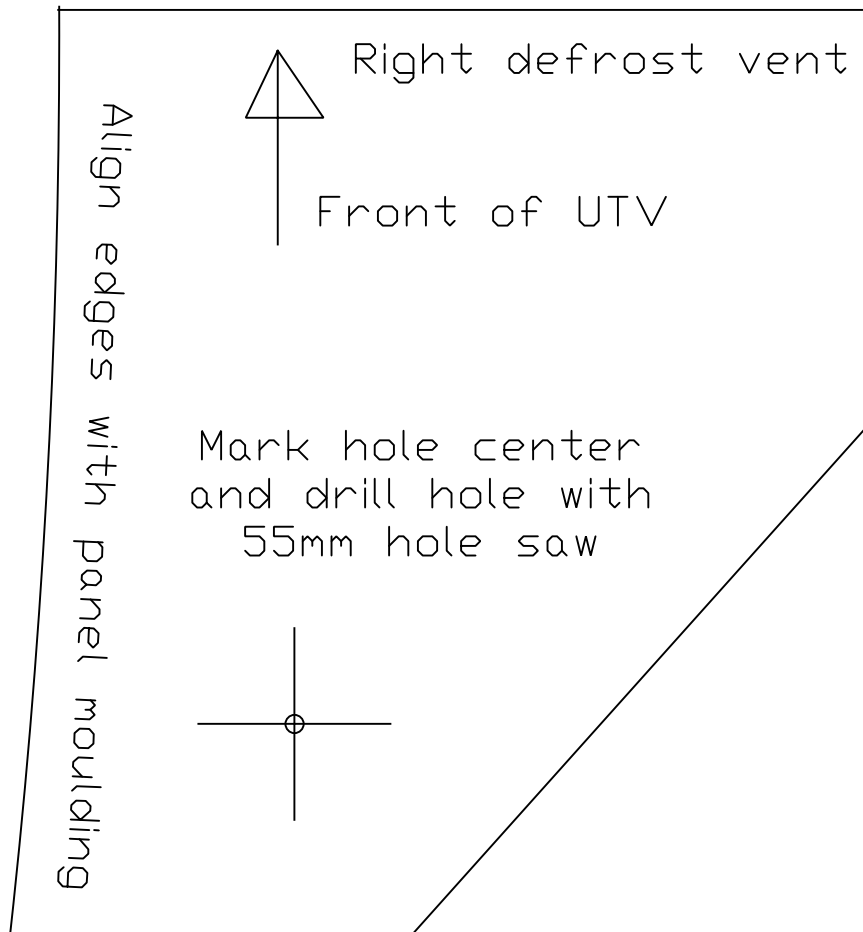

Please note: Before drilling any holes check area behind firewall/dash panels to make sure no damage or interference with equipment will occur by drilling holes and fitting of vents.

Left Defrost Vent Template

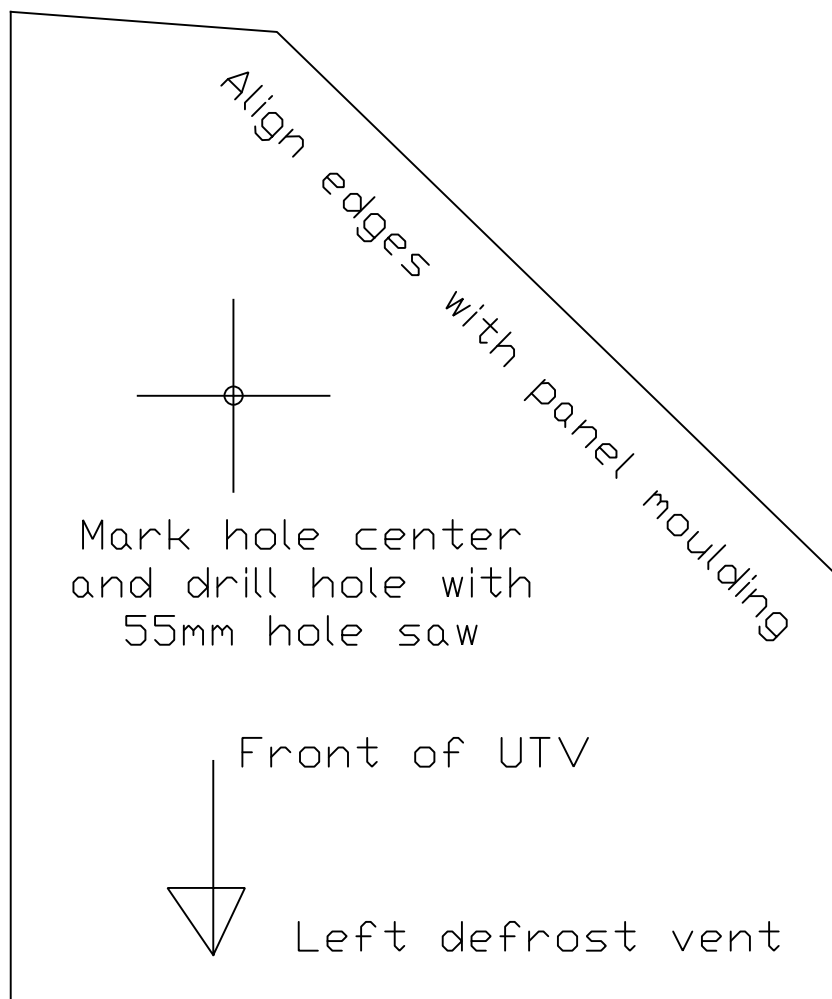

Please note: Before drilling any holes check area behind firewall/dash panels to make sure no damage or interference with equipment will occur by drilling holes and fitting of vents.

Center Vents Template

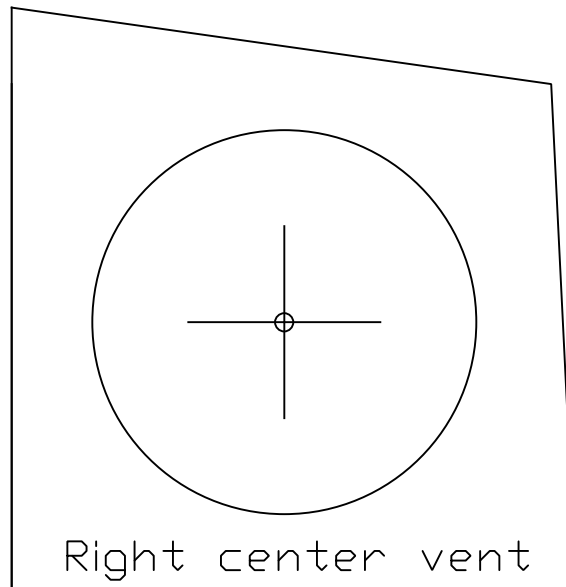
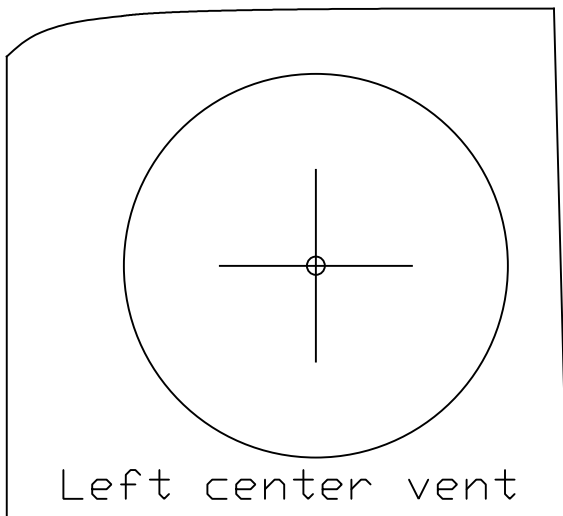

Mark hole centers
and drill hole with
55mm hole saw

Please note: Before drilling any holes check area behind firewall/dash panels to make sure no damage or interference with equipment will occur by drilling holes and fitting of vents.