

RK-FR-H520-HL

Honda Foreman/ Rubicon 520 & Rancher 420 ATV (Non-Power Steering)
Radiator Relocation Kit



HL

Parts Available For These Popular Brands and Others

POLARIS

can-am



Kawasaki



HIGHLIFTER



sales@highlifter.com



800-699-0947 | 8:00am - 6:00pm CST



780 Professional Drive North, Shreveport, LA 71105



www.highlifter.com

READ BEFORE INSTALLATION

WARNING:

Be advised that there are certain hazards of burning or scalding, that are created by installing radiators with potentially boiling hot fluids in locations other than those selected by the ATV manufacturer. By relocating the radiator, the customer and installer indicate that they understand and accept all risks and liability that are or may be created by moving the vehicles radiator to a non standard location.

The purchaser and installer hereby release High Lifter, it's officers, and employees from any and all potential responsibility that may arise from installation of this radiator relocation kit. It is also the duty of the installer or purchaser to inform the rider or next owners of these potential hazards.

Upon completion verify all hoses and wires are not touching or rubbing the plastic. Vibration **WILL** rub a hole in the lines very quickly. Zip-tie all lines and hoses securely.

PARTS DIAGRAM

NOTICE: SOME PARTS AND PHOTOS WILL VARY FROM ONE MODEL TO ANOTHER.

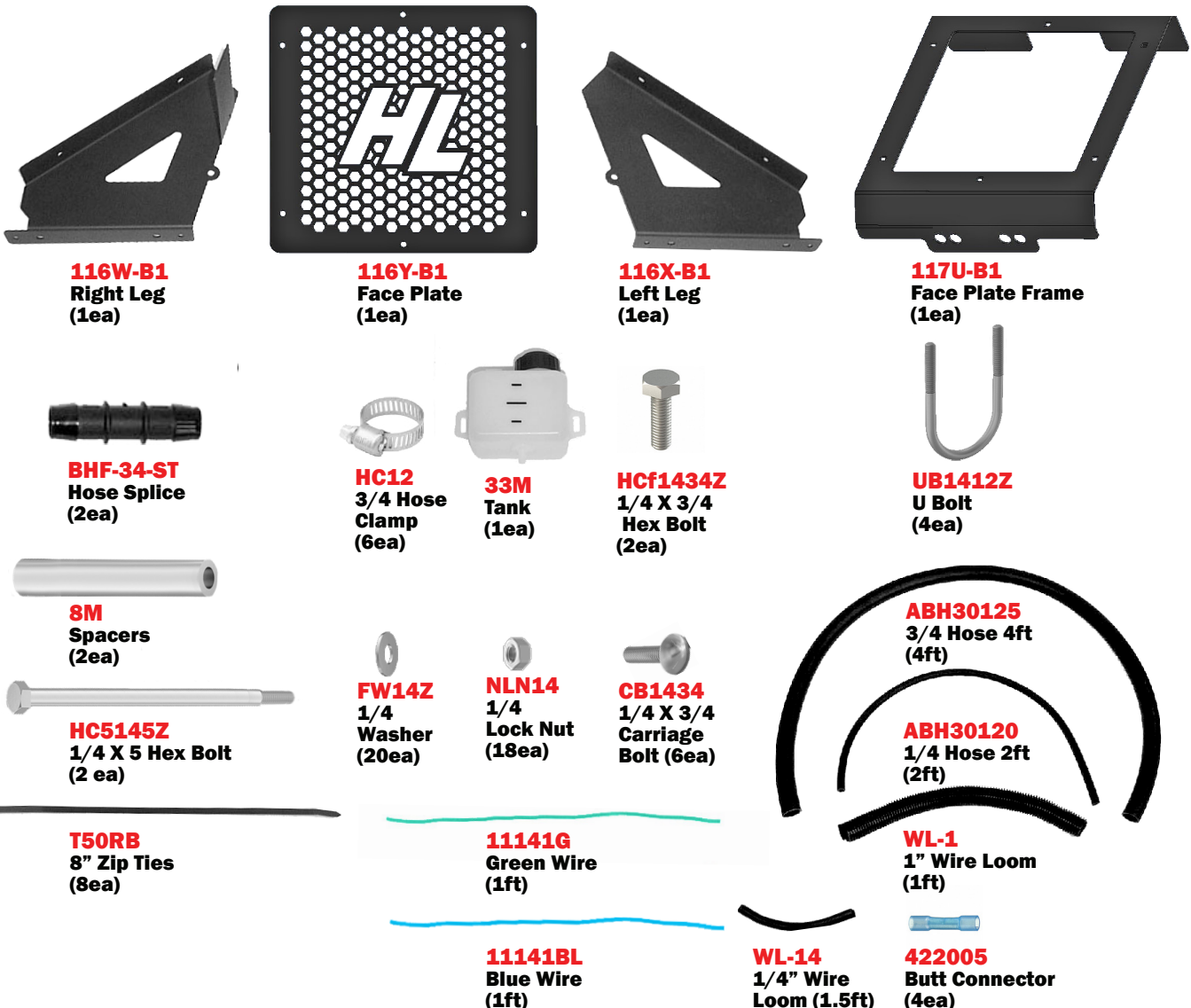

1

These items will need to be removed from the ATV, but leave the radiator attached to the fan and bracket. FOLLOW THE PROCEEDING STEPS FOR SPECIFIC INSTRUCTIONS ON REMOVAL.

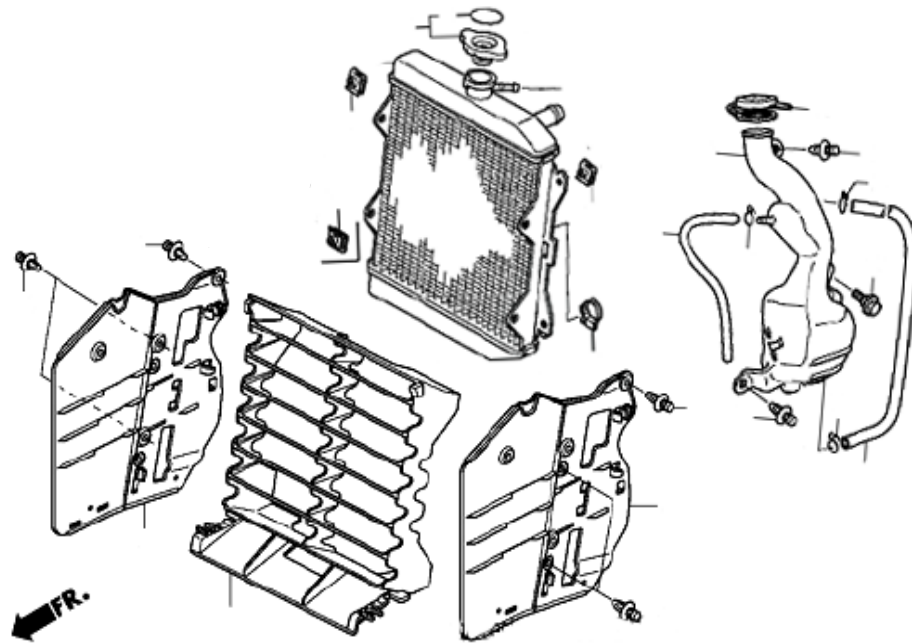

REMOVING STOCK COMPONENTS

2

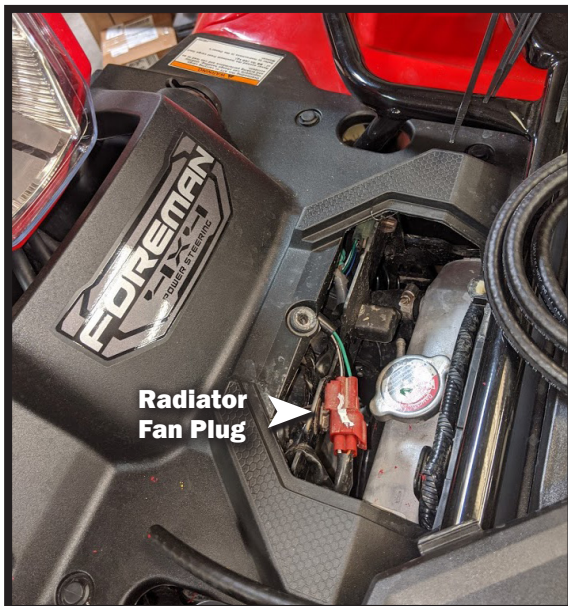

Remove the cover from the top of the ATV to access the radiator, then unplug the radiator fan plug.



Dispose of used fluid according to your local regulations. Use care in disposal, antifreeze is toxic.

REMOVING STOCK COMPONENTS

3

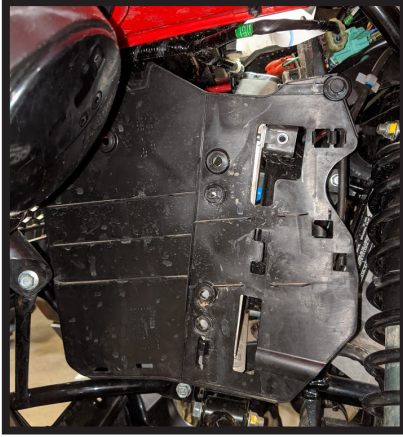

Remove the **plastic covers** to access the radiator.

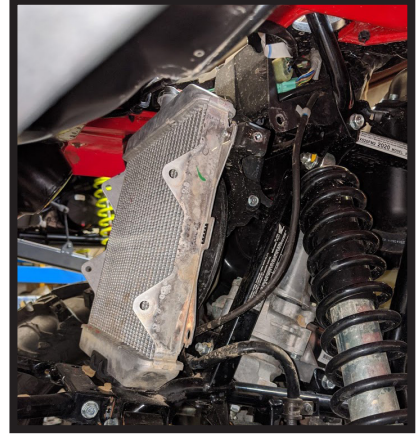
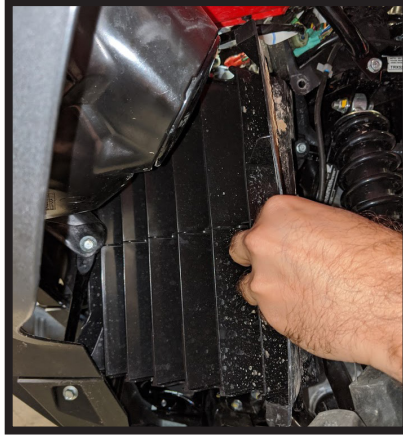

Begin to disconnect **hoses** and **drain fluid** from the radiator, being sure to leave **stock radiator hoses** attached to the engine.

REMOVING STOCK COMPONENTS

4

Remove radiator assembly from the ATV and set aside.

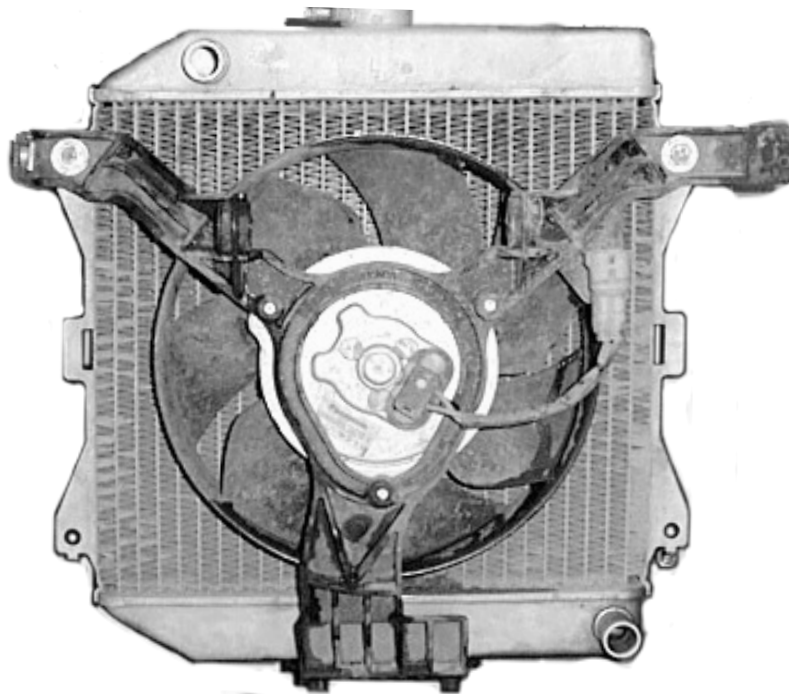

ASSEMBLING RADIATOR MOUNT

5

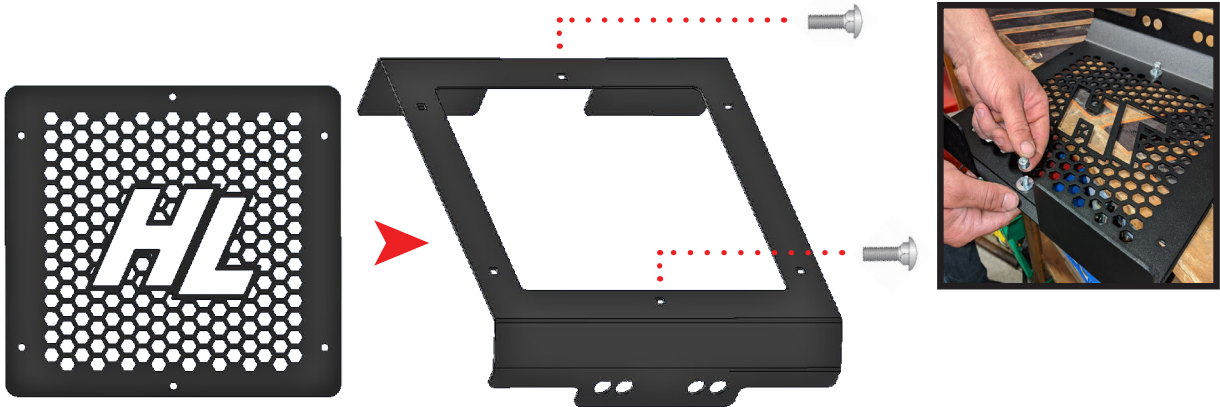

Start preassembling the the radiator mount by placing the **face plate BEHIND** the **plate frame** and install the **two 1/4 X 3/4 carriage bolts** to the center bolt holes then back it with the **two 1/4 washers** and **1/4 lock nuts** provided.

6



Attach the **left and right leg**, then begin installing the remainder of the **carriage bolts washers and lock nuts** and tighten them. **(6 total)**

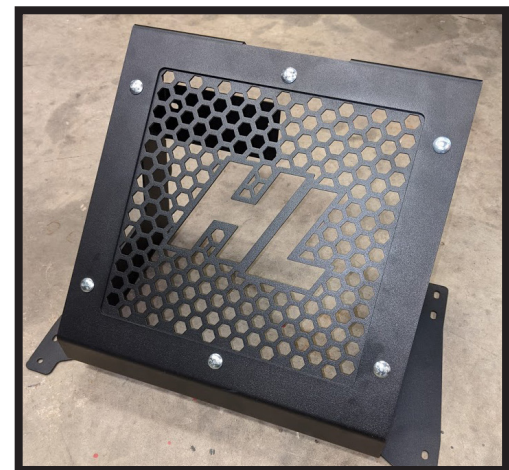

7

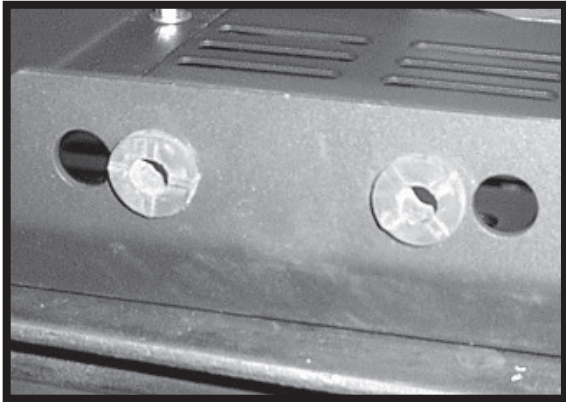

Where the bottom of the stock radiator attaches to the frame there are two **rubber grommets** that you will need to **remove** and place in the two center holes at the base of the new **face plate**.

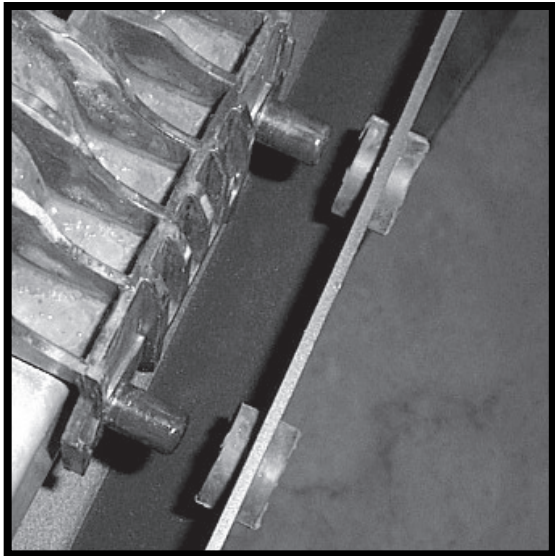

Once they are installed you will need to then insert the bottom of the radiator into the **grommets**.

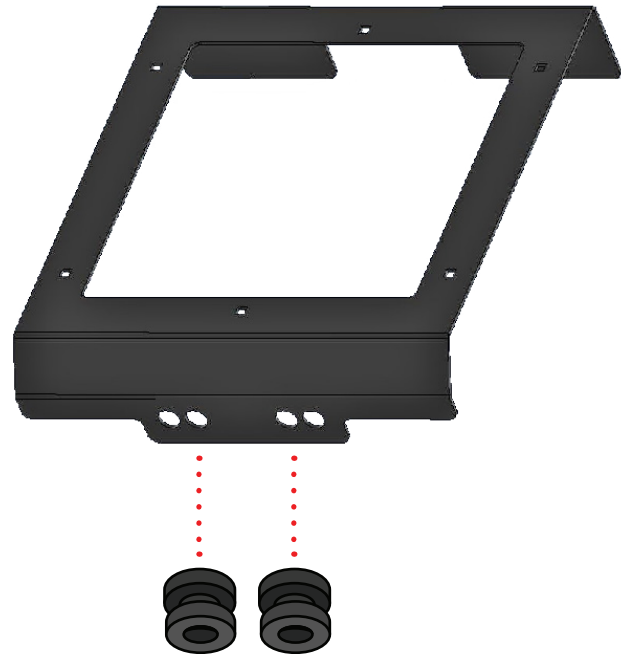

FAN INSTALL

Trim Brackets

8

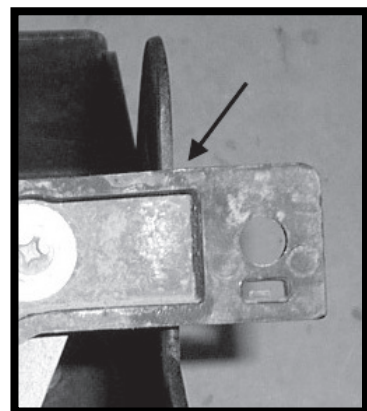
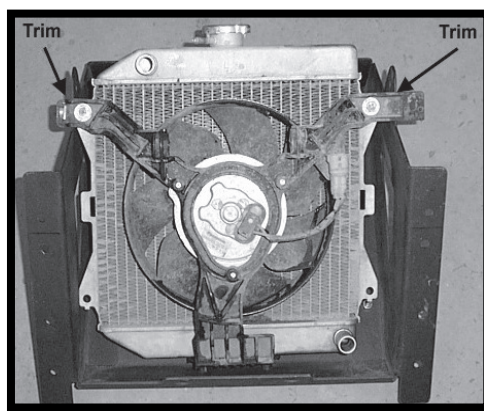
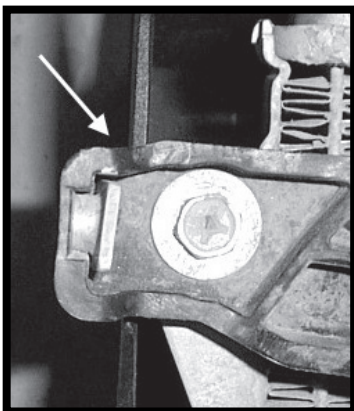

You will need to **trim** the stock **radiator fan brackets**, so that it will fit into the new shroud.

9

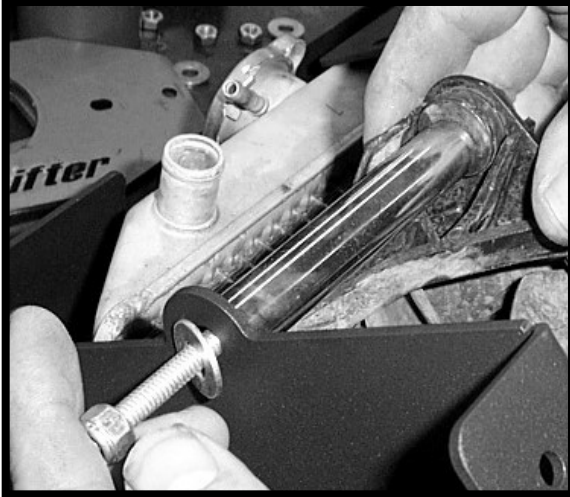

Next use the two **large spacers** and **1/4 X 5 bolts** to connect the fan to the brackets.

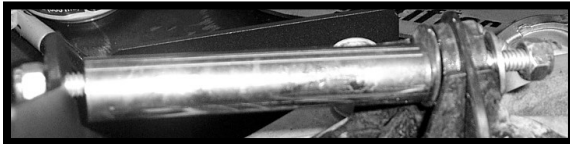

Place a **1/4" washer** on the bolt, push it through the connecting point of the frame. Next place a **spacer** on the bolt, then slide the bolt through the fan and secure it with **1/4" washer** and **1/4 lock nut**.

FAN INSTALL

10

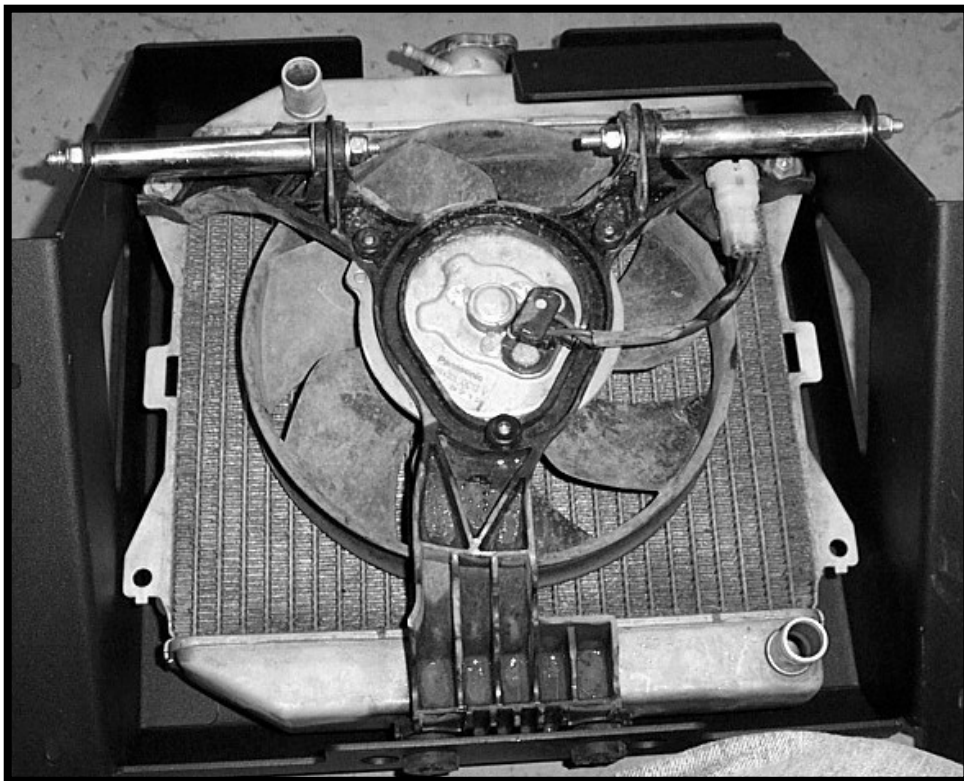

Once that is complete, your results should look like this.

11



Cut the **blue and green wire** half way between the **plug** and the **motor** on the back of the fan.

12

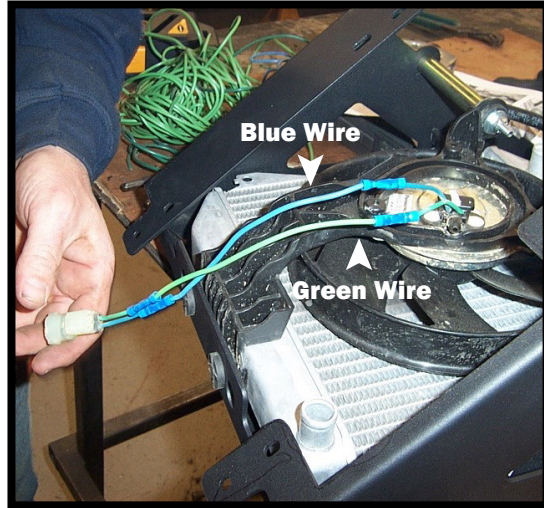
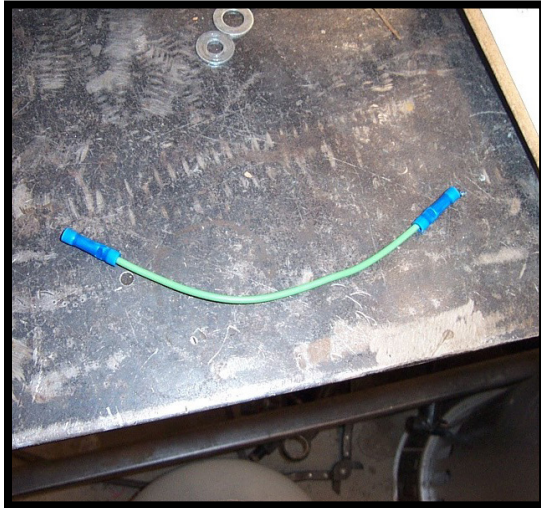

Using the **butt connectors** and **wire** provided, extend the **fan plug**. Attach the **green to green** and **blue to blue**.

NOTE: Once you have connected the wires, **wrap them in black tape** for added protection. Then **wrap them in 1/4 wire loom**.

Once the kit is assembled, place the kit on the front rack and loosely connect the **U-bolts** to the frame to prepare wire and hose routing.



HOSE & WIRE ROUTING

13



Mark all holes to be drilled for the radiator hose then remove the radiator from the rack.

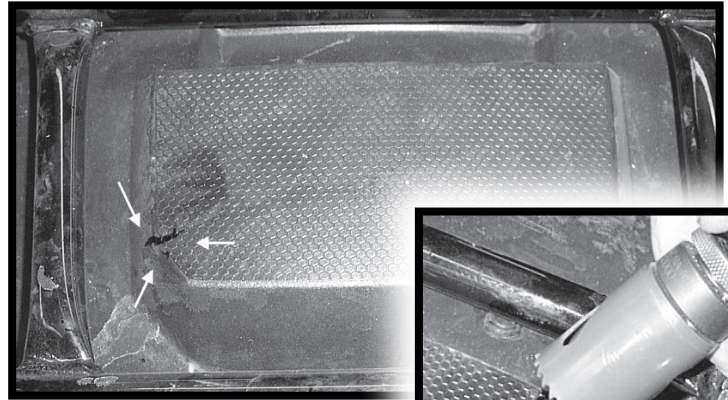

With a hole saw, drill the hole in the plastic, it needs to be **1 3/8"** in diameter.

14

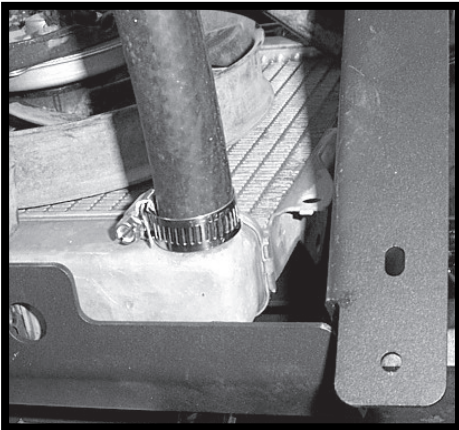

Connect **2ft** of hose to the bottom of the radiator. Secure the hose to the lower portion of the radiator with the **clamp** provided.

Cut **1"** wire loom in half and wrap the hose before inserting it through the plastic.



You need to insert the hose through the hole you drilled in the plastic as you are installing the radiator relocation kit to the rack.

15

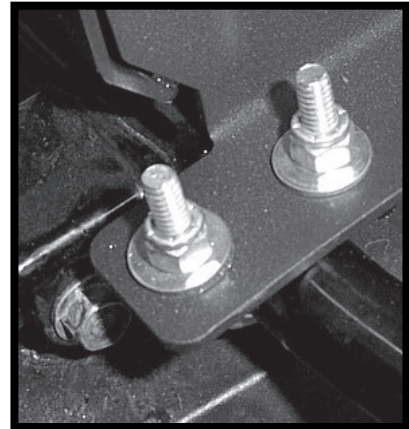
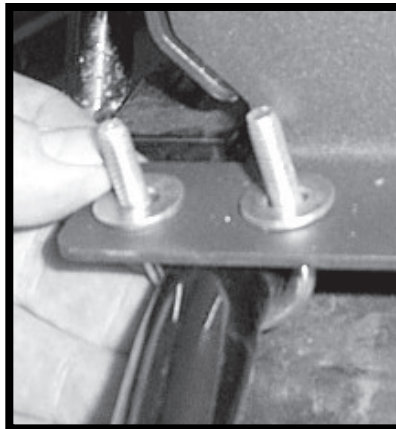
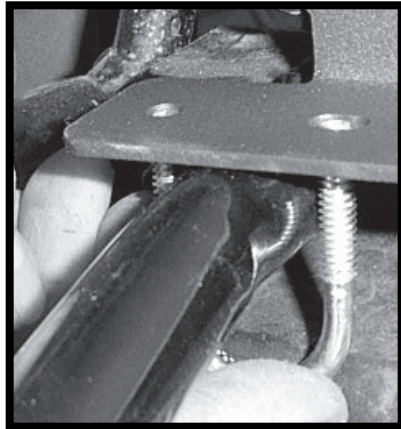

Connect the radiator to the rack using the 1/4 x 1" bolts, U-bolts, 1/4" washers and 1/4" lock nuts provided in the kit.

Access Panel Modification

16

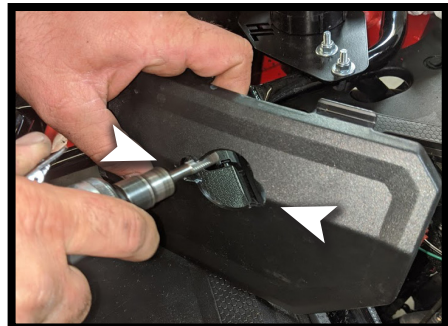
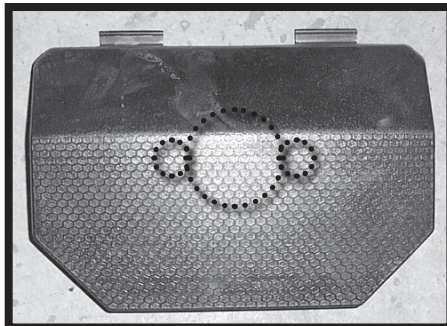

Locate the access panel and cut a 1 3/8" in hole in the center. If you DO NOT have a rotary tool we recommend you to use a 1/2 drill bit to drill out holes on the side for extra wiring space BEFORE drilling the 1 3/8 hole.

Mounting Tank

17

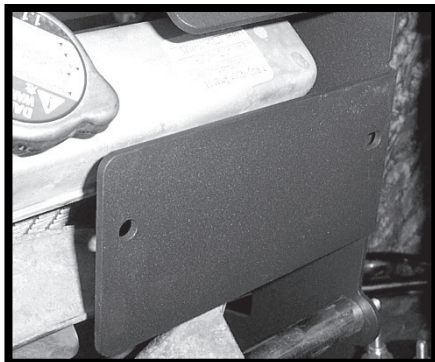

Located on the right leg of the relocation kit, connect the over flow tank to the mount. Use the 1/4" x 3/4" hex bolts, 1/4" washers, and 1/4" lock nuts provided.

18

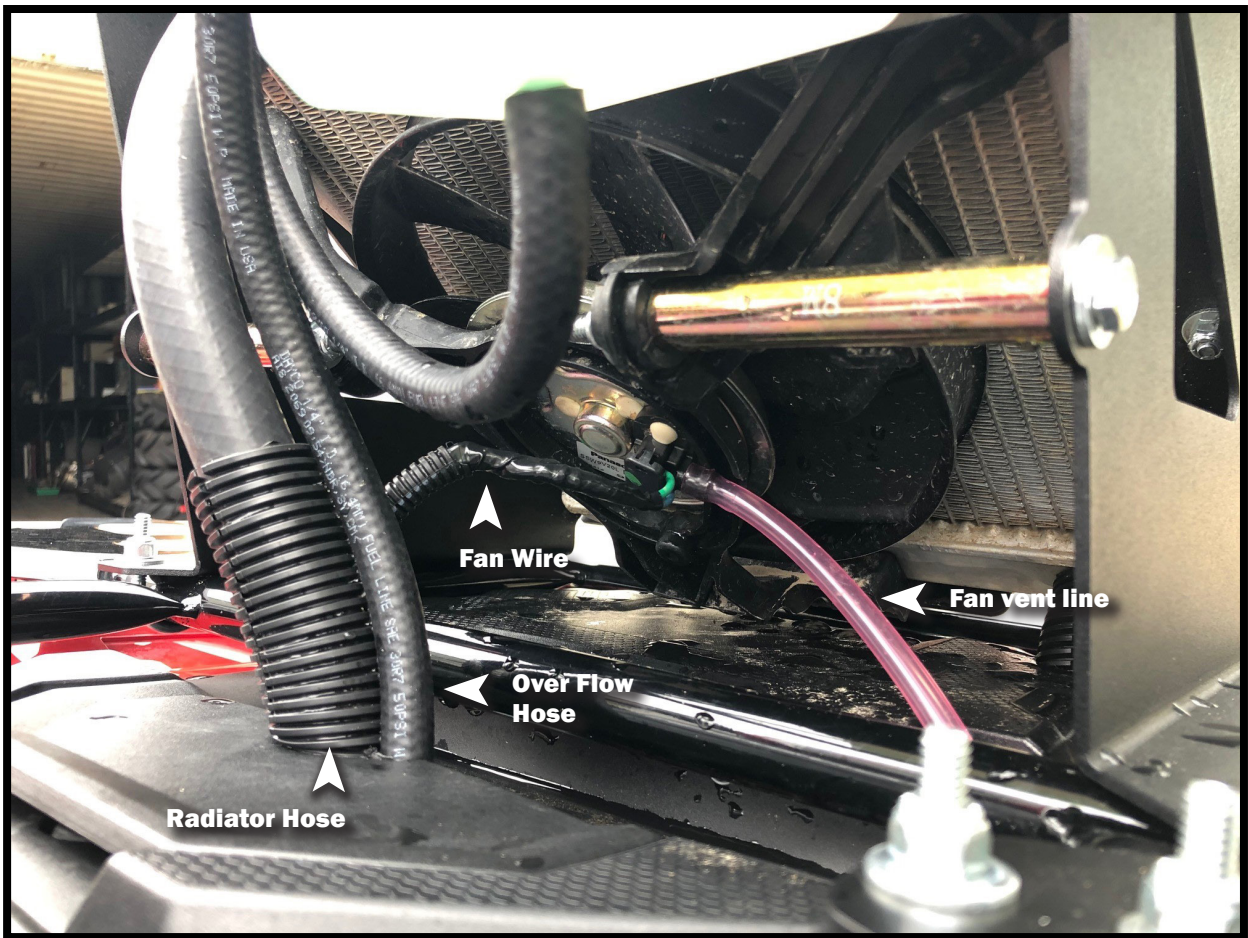

IMPORTANT: Place the **remaining loom** around the **hose** to keep it from rubbing on the rack and plastic fenders. If the hose is left unprotected the vibration of the hose against the rack and fenders will form a hole, causing fluid to leak out, potentially **RESULTING IN ENGINE DAMAGE**. **MAKE SURE ALL HOSES AND WIRES ARE COATED WITH LOOM.**

Fan and Hoses

19

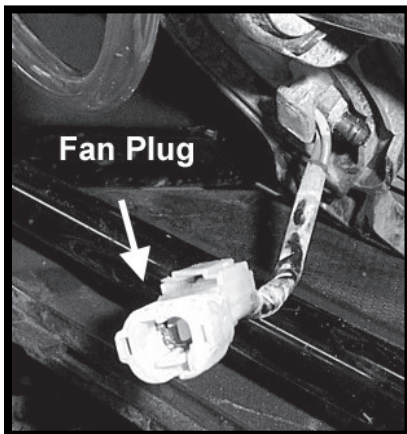

Push the fan wire through the access panel and reconnect it.

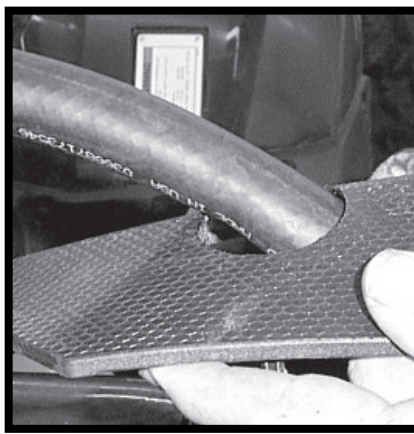

Now run 2 ft of hose through the access panel and cover it with loom.



HOSE & WIRE ROUTING

20



Route the hose through the **access panel** down, and leave hoses hanging below. Then connect the other **end of hose to the top of the radiator** with a **clamp**.

Use the **zip ties** provided in the kit to secure all **lines, hoses, and wires**, so that they do not allow rubbing.

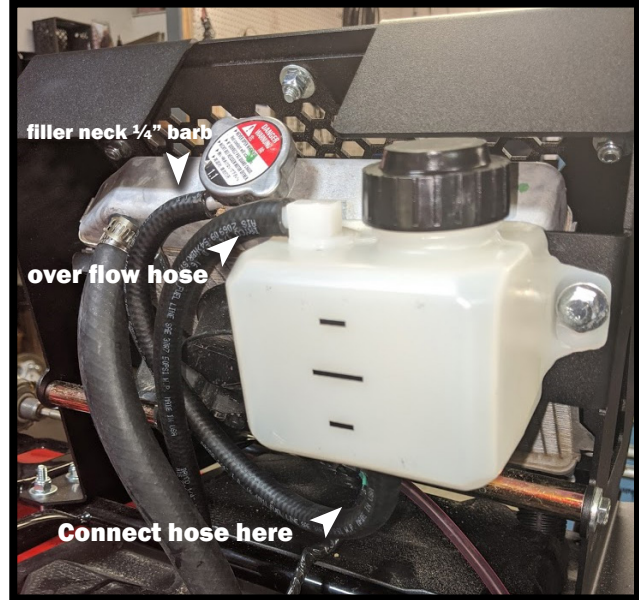

Connected to the radiator **filler neck** is a **1/4" barb**, cut **10"** of the **black 1/4" hose** provided, then connect the **1/4" black hose** to the **barb** on the **filler neck** and to the **1/4" barb** on the **bottom of the over flow tank**.

Using the remaining **1/4" black hose** provided, **route the over flow hose** from the tank down through **access panel**.

HOSE & WIRE ROUTING

Radiator Hose Splice

21

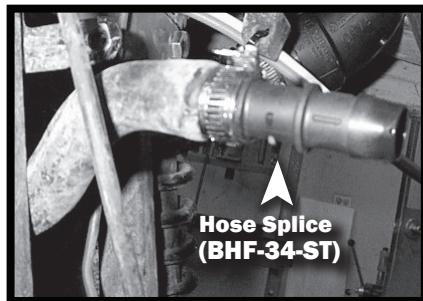

Once you have pushed the hoses through, connect the **inlet and outlet hoses** to the hoses you **left connect to the engine**. Secure the **hoses** to the **fitting** with the **clamps** provided in the kit.

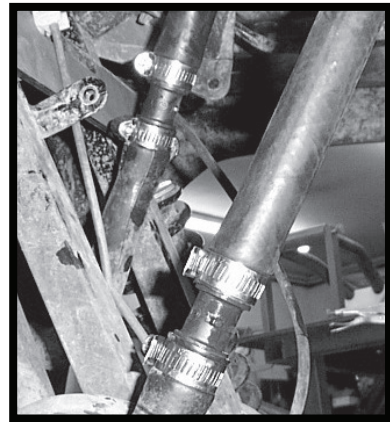
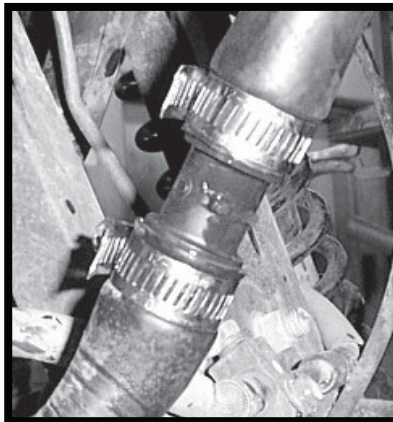

Fill radiator with factory approved fluids and check levels after a short distance. Air can get trapped in the system, so be sure that the levels are efficient. **The tank should be on the middle mark.**

CONGRATULATIONS! Enjoy Your new High Lifter Radiator Relocation Kit!



Thank You
For Choosing
HIGHLIFTER



High Lifter Lifetime Warranty

From the beginning, High Lifter has engineered and manufactured some of the toughest, most durable products on the market. That's why this product comes with a Lifetime Warranty. It's our promise that High Lifter will never let you down.

What We Cover

- The Lifetime Warranty covers products sold to the original purchaser only and is not transferable. The term of the warranty is for the lifetime of the vehicle in question.
- Normal wear and tear items and finishes, such as, but not limited to: Heim joints, tie rod ends, ball joints, bearings, seals, bushings, bushing sleeves, zinc plating , powder coating, or chipping and discoloration of any finish is not covered.
- High Lifter will ship the replacement product after the returned product has been inspected by High Lifter staff.
- The warranty shall not include claims for damages, installation time or labor charges, economic losses, inconvenience, transportation, towing, down time, direct or indirect or consequential damages or delay resulting from any defect.
- The warranty does not apply to products that have been improperly applied or improperly installed.

Making a warranty claim

- 1 All claims must be accompanied by the part and the original sales receipt or other acceptable proof of purchase from the original owner.
- 2 All warranties must be accompanied with a Return Merchandise Authorization (RMA) number. **(Contact High Lifter at 318-524-2270 or 800-699-0947 for an RMA number)**
- 3 When shipping the damaged product:
 - a. Write the RMA number on the outside of the box.
 - b. Also include the RMA number, proof of purchase and any notes inside the box.
 - c. Please keep your tracking number and shipment information.
4. The customer is responsible for shipping the product to High Lifter--return shipping within the lower 48 states will be paid by High Lifter products. With all warranty claims, only standard shipping services apply.
5. High Lifter will process your order within 24 business hours of receiving the returned item.
6. **Ship to:** High Lifter Products, 780 Professional Drive North, Shreveport, Louisiana 71105