

HDAS-P-03 RNG1

POLARIS RANGER 1000 ADJUSTABLE TIE ROD

HL

HIGHLIFTER

SEIZMIK™

FALCON RIDGE

SNORKEL YOUR ATV

SYSTEM 3
OFF-ROAD
Traction. Strength. Style.

EPI
PERFORMANCE

✉ sales@highlifter.com
☎ 800-699-0947 | 8:00am - 5:00pm CST
📍 7455 Atkinson Drive, Shreveport, LA 71129



www.highlifter.com

Parts Available For These Popular Brands and Others

POLARIS

can-am



HONDA

Kawasaki

YAMAHA

PRODUCT DISCLAIMER

The installation of products sold or manufactured by High Lifter Products, Inc. including, but not limited to suspension components such as lift kits, gear reduction lifts, frame stiffener kits, snorkels, and tires that exceed the original specifications for the vehicle, may change the vehicle's center of gravity and handling characteristics both on- and off-road. You are aware that the installation of tires that are larger than original vehicle specifications may reduce the effectiveness of the braking system. Use of these products may place added stress to the original factory vehicle components which could cause them to weaken or possibly fail.

Products sold or manufactured by High Lifter Products, Inc. are intended for off-road use only. Operation of a vehicle modified with these products on a road could result in serious bodily injury or death, and such operation may violate the laws of your state or municipality. You agree to operate your vehicle exclusively in the manner intended by the vehicle manufacturer. You agree that failure to safely and reasonably operate your vehicle could result in serious bodily injury or death, and that, as a result of installation of this product(s) to your vehicle, extreme care must be taken to prevent vehicle rollover or loss of control, which may be more likely to occur as a result of said modifications. You will avoid unsafe maneuvers, including sudden sharp turns or other abrupt maneuvers, which could make a vehicular accident more likely. You understand that High Lifter Products, Inc. is not responsible or liable for any damages or any injuries to yourself or your passengers that could occur upon possible accidents due to driver error, incorrect installations, bad judgment, incompatibility with other aftermarket accessories or natural disasters to the fullest extent allowable by law.

You will have all vehicle occupants fasten seatbelts, if equipped, and wear proper safety equipment, such as DOT approved helmet and eye protection prior to operating the vehicle. You understand and acknowledge that failure to wear proper safety equipment may increase the risk of serious bodily injury or death to yourself and any passengers.

Proper installation of products sold or manufactured by High Lifter Products, Inc. requires knowledge of the factory recommended procedures for removal and installation of original equipment components. Installation of these products without proper knowledge and experience may affect the performance of these components and the safety of the vehicle and cause serious bodily injury or death. It is strongly recommended that a certified mechanic familiar with the installation of similar components perform the product(s) installation.

Prior to installing any products sold or manufactured by High Lifter Products, Inc., you will perform or cause to be performed an inspection of their vehicle to confirm its condition is suitable for the installation of these products. A proper inspection of the vehicle includes confirmation that the vehicle has not been in a collision and is free of corrosion. If the vehicle is suspected to have been in a collision or misused, or is otherwise unsuitable for modification, you will not install the product(s). You will continue to inspect the vehicle prior to each use to confirm its condition is suitable for its intended use, and you acknowledge that the failure to do so may result in serious bodily injury or death, as well as damage to the vehicle itself.

You will install any warning labels provided with the product so it may be prominently seen by yourself and all passengers. You will notify all passengers of the modifications performed to your vehicle prior to operation.

Insurance companies may handle coverage of a modified vehicle differently. Please check with your insurance carrier prior to modifying the vehicle to ensure your coverage remains sufficient.

Installation of this product(s) may void your vehicle warranty. If this is a concern, please check with the manufacturer or dealer before purchase or installation of this product(s).

HIGHLIFTER



HIGH LIFTER LIMITED LIFETIME WARRANTY

High Lifter offers a Limited Lifetime Warranty to the original purchaser that our product shall be free from defects in material and workmanship for the life of the product if utilized in accordance with the manufacturer's instructions for installation and operation of said products.

LIMITED LIFETIME WARRANTY EXTENDS TO THE FOLLOWING PRODUCT LINES:

- **Lift Kits (Signature, Standard and Big Lifts)**
- **Control Arms**
- **Trailing Arms**
- **Radiator Relocation Kits**
- **Portal Gear Lifts**
- **Wheel Spacers**
- **Tow Hooks**
- **Control Arm Link Kits**

Damages to vehicle or any other object during the installation, use, or removal of High Lifter products are not covered under this warranty. Normal wear items included with any of the products covered under this Limited Lifetime Warranty are excluded from coverage. These items include, but are not limited to heim joints, tie rods, bearings, bushings, seals, gaskets, zinc plating, painted and powder coated finishes. Other exclusions of coverage under this warranty include, but are not limited to: damage or product failure due to improper installation, lack of maintenance, product modification, abuse, collision or use on vehicles for which product was not designed, repairs performed by anyone other than approved High Lifter personnel or made using non-High Lifter components. This warranty is valid for the original purchaser only and is non-transferable. High Lifter reserves the right to inspect any product before determining if the claim is valid and covered under this warranty. Claims determined to be caused by reasons other than a manufacturer defect will be rejected and an estimate for repair or cost of a replacement product if a repair is not possible, will be provided.

This warranty is exclusive and is in lieu of any implied warranty of merchantability, fitness for a particular purpose or other warranty of quality, whether express or implied, except the warranty of title.

WARRANTY PROCESSING

If you suspect your product is defective, **DO NOT** disassemble the product to determine the cause without prior approval as it may void your warranty status. This is especially true with our Portal Gear Lift. To begin the claim process, please e-mail our warranty team at warrantycare@highlifter.com and include the following in the e-mail:

- Your full name, address and contact phone number.
- The year, make and model of your vehicle
- The part number of the product
- Photos of the product installed, and vehicle product is installed on
- Proof of Purchase (Required for all warranty claims and you must be the original purchaser)

Once a claim is created, you will receive a return authorization number (RMA). Write this number on the outside of the box containing your defective product and include it along with your name and contact information inside the box. Product must be returned in the original box or a box of equal strength and packaging. Product sent without an RMA number visible on the outside of the box or sent COD will be refused. Ship your product to the following address:

High Lifter Products, Inc.
Attn: Returns 7455 Atkinson Dr, Shreveport, LA 71129

Once your product is received, we often have your replacement or repaired product shipped back to you within 3-business days of receiving it. Please note that High Lifter is not responsible for shipping charges on product returned for warranty or repair, including duties and fees required by those residing outside the United States.

THANK YOU FOR CHOOSING
HIGHLIFTER

79-15314

PARTS

POLARIS RANGER 1000 ADJUSTABLE TIE ROD

79-15138



(2 EACH)

79-10719
HEIM JOINT
3/4-16 RH

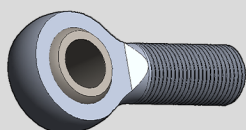

2 (EACH)

54-60881
3/4 JAM NUT RH

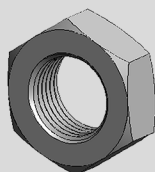

2 (EACH)

78-10224
(14MM)
INNER TIE ROD END



2 (EACH)

54-60930
5/8- LH
JAM NUT

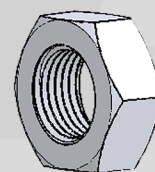

2 (EACH)

54-60937
BLUE LOCKTITE
MED STRENGTH 1.8ML



1 (EACH)

79-14420
HIGH MISALIGNMENT
BUSHING

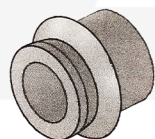

2 (EACH)

54-61027
12MM
FLAT WASHER



2 (EACH)

54-96044
12MM X 1.5
NYLON LOCK NUT



4 (EACH)

79-14419
HIGH MISALIGNMENT STUD
10 DEGREE

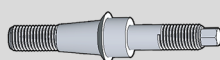

2 (EACH)

54-61334
11" ZIP TIES



4 (EACH)

STEP 1

STOCK TIE ROD REMOVAL

STEERING ASSEMBLY

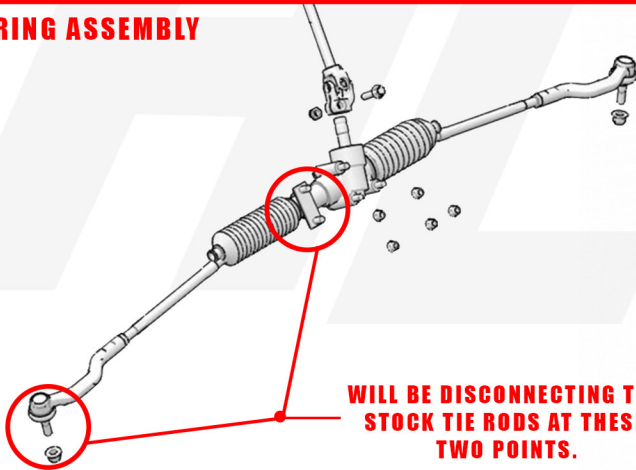

WILL BE DISCONNECTING THE STOCK TIE RODS AT THESE TWO POINTS.



PLACE JACK UNDER THE CENTER OF FRONT AND LIFT UNTIL THE WHEELS ARE OFF THE GROUND. BE CAREFUL TO SECURE PROPERLY SO IT IS STABLE ON THE JACK OR JACK STANDS. REMOVE WHEELS.



STEP 2

STOCK TIE ROD REMOVAL

DISCONNECT THE TIE ROD END FROM THE KNUCKLE BY REMOVING THE FACTORY NUT ON THE UNDERSIDE OF THE KNUCKLE.

NEXT, WHILE APPLYING UPWARD PRESSURE ON THE TIE ROD GENTLY TAP THE KNUCKLE WITH A HAMMER TO HELP SHOCK/EASE THE TIE ROD OUT.



STEP 3

STOCK TIE ROD REMOVAL

REMOVE CLAMPS AND/OR ANY ZIP TIES HOLDING THE BOOT IN PLACE. NOW, SLIDE THE BOOT DOWN THE TIE ROD.

WHEN THE TIE ROD IS REMOVED FROM THE UTV YOU WILL REUSE THE BOOT TO INSTALL THE NEW ADJUSTABLE TIE ROD.

NOTE: INSPECT THE BOOT FOR ANY RIPS.

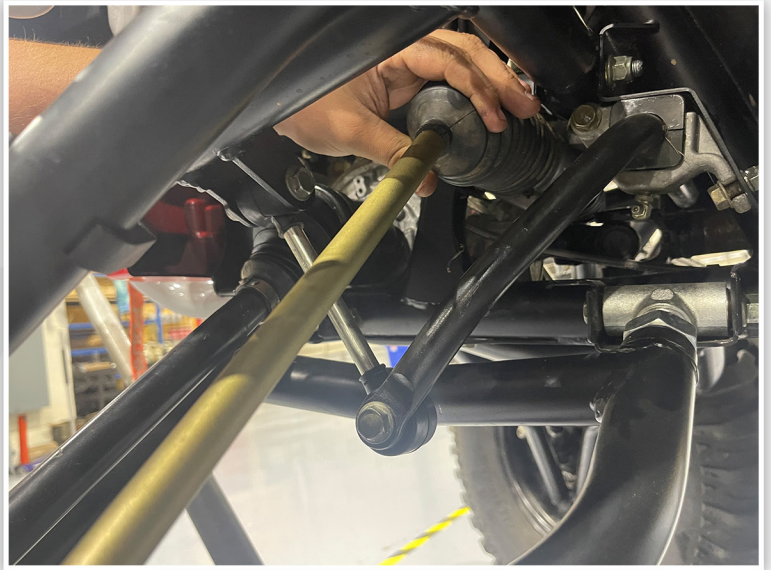

NEXT, LOOSEN THE INNER TIE ROD END FROM THE RACK.

NOTE: GO COUNTER CLOCKWISE TO LOOSEN.

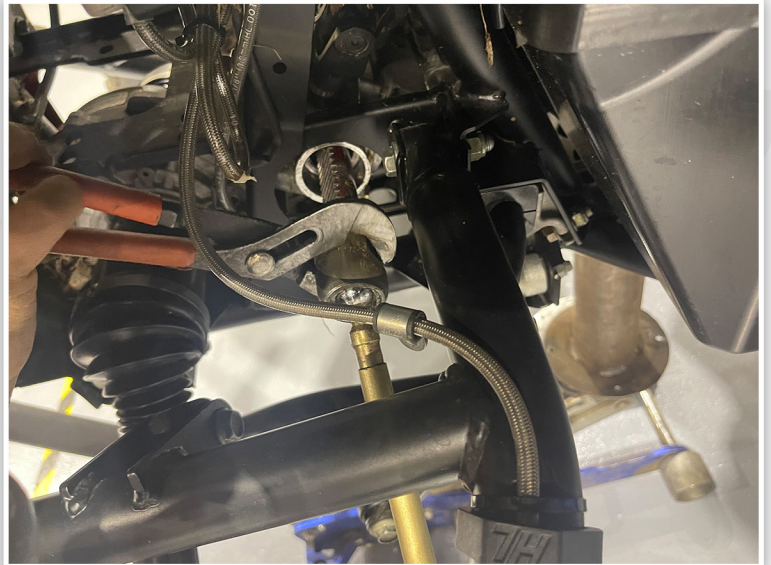

REMOVE THE STOCK TIE ROD.



STEP 4

MEASURING AND TIE ROD ASSEMBLY



MEASURING

MEASURE THE STOCK TIE ROD FROM THE CENTER OF THE HEIM JOINT ON THE TIE ROD END TO THE END OF THE INNER TIE ROD END. USE THIS MEASUREMENT FOR THE NEW TIE ROD.



1. TAKE THE FACTORY BOOT AND PLACE IT ONTO THE NEW INNER TIE ROD.

2. NEXT, ATTACH THE HEIM JOINT TO THE OUTER END OF THE TIE ROD THAT WILL CONNECT TO THE KNUCKLE ASSEMBLY. SCREW IT ON WITH THE JAM NUT LEAVING 1/4" OF THREAD.

3. NOW ATTACH THE STUD TO THE HEIM JOINT USING THE LOCK NUTS AND THE MISALIGNMENT BUSHING AND THEN TIGHTEN.

4. NOW CONNECT THE INNER TIE ROD END TO THE END THAT WILL CONNECT TO THE RACK. SCREW IT IN AND THEN SECURE IT WITH THE JAM NUT LEAVING 1/4" INCH OF THREAD.

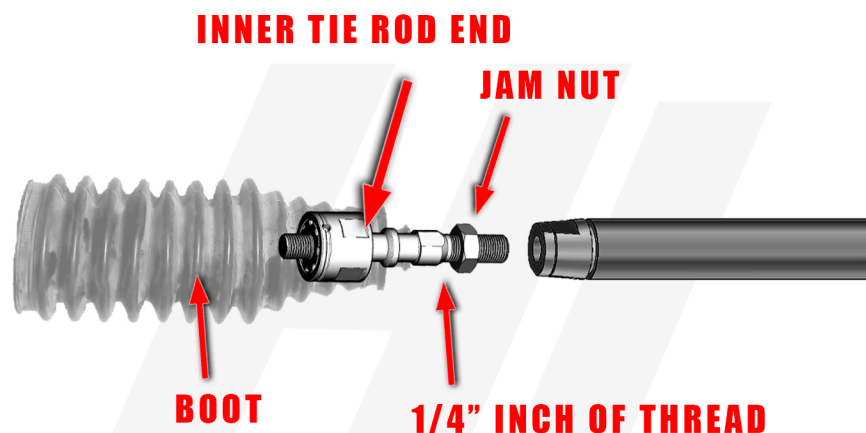
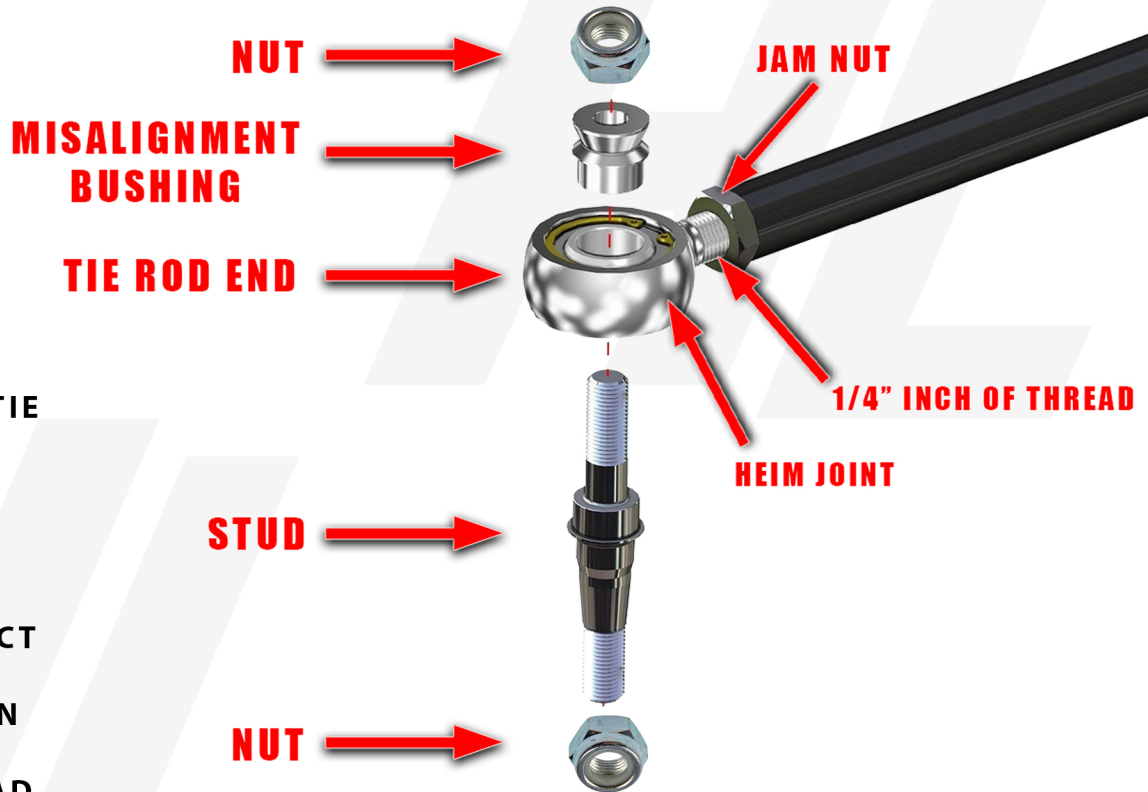

5. SET THE LENGTH OF THE NEW ADJUSTABLE TIE ROD TO THE MEASURED LENGTH OF THE ORIGINAL TIE ROD. DO THIS BY ADJUSTING THE TWO TIE ROD HALVES.

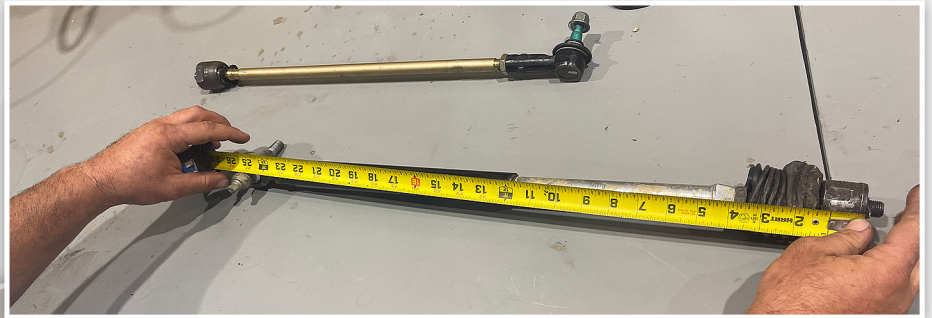

ONCE THE TIE ROD END AND THE INNER TIE ROD END ARE COMPLETED SET THE TIE ROD TO THE STOCK TIE RODS MEASUREMENT. NOW, USING AN ALLEN WRENCH SET THE FIRST SET SCREW ONCE IT IS ALIGNED ALONG THE CHANNEL ON THE TIE ROD AS SEEN IN THE IMAGE TO THE LEFT. NOW SET THE SECOND SET SCREW ON THE SIDE.

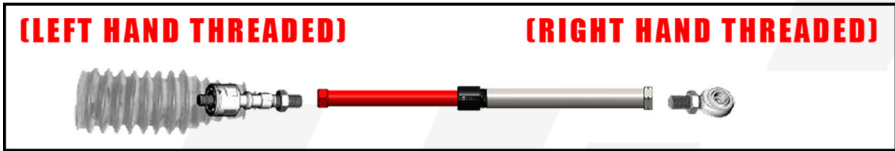

STEP 5 INSTALLATION

INSTALL THE INNER TIE ROD END BY FIRST APPLYING SOME LOCKTITE TO THE THREADS THEN THREAD THE TIE ROD ONTO TO THE RACK AND TIGHTEN.

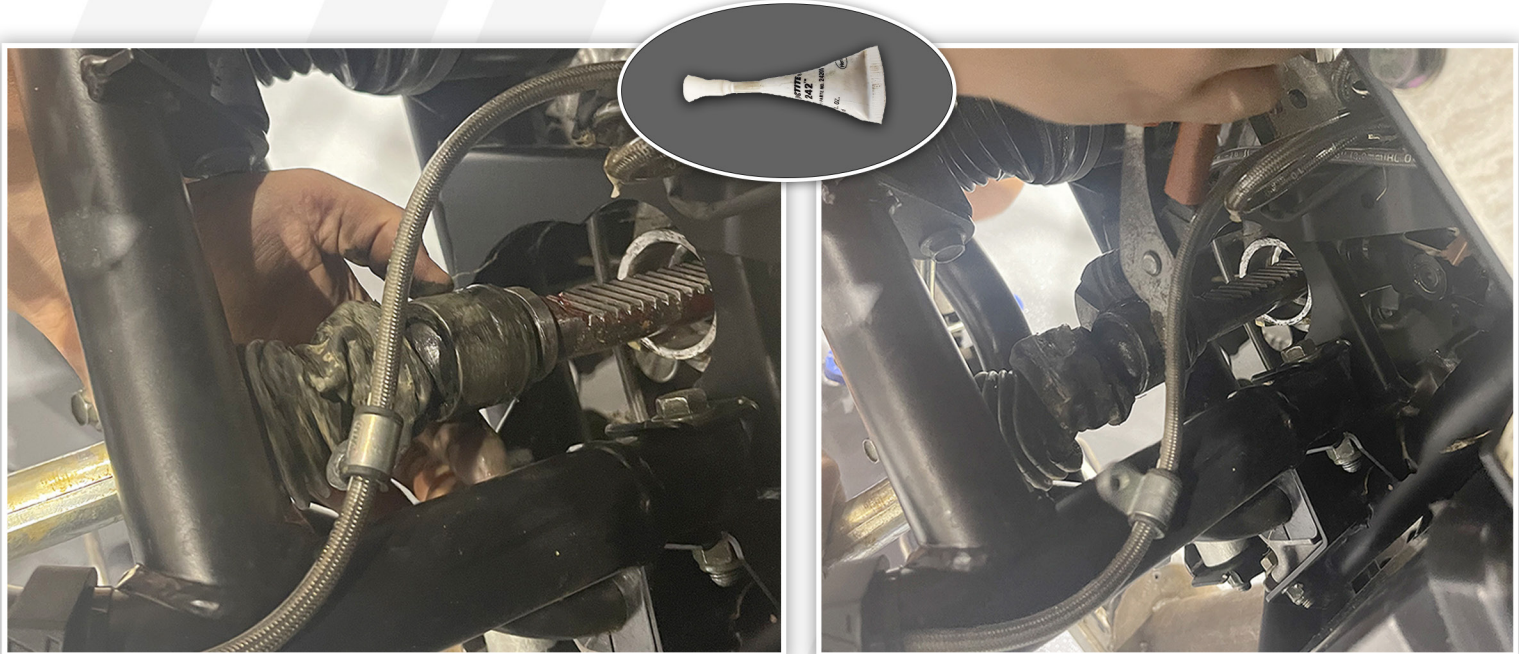

NOW SLIDE THE BOOT BACK AND SECURE IT TO THE RACK WITH 2 ZIP TIES.

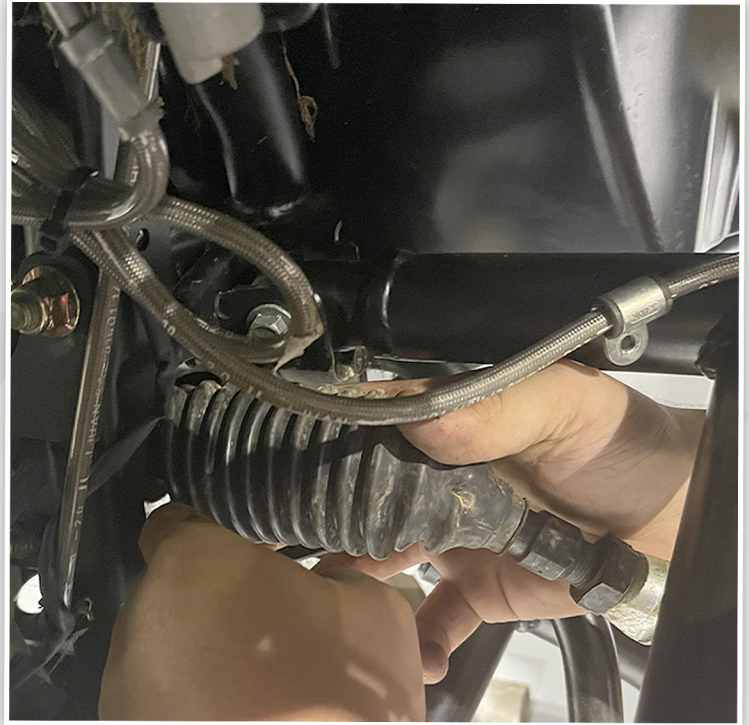

STEP 6

INSTALLATION

NOW INSTALL THE TIE ROD END TO THE KNUCKLE USING A 12MM FLAT WASHER THEN THE 12MM LOCK NUT.

ONCE ALL IS TIGHTENED REPEAT STEPS FOR OPPOSITE SIDE, REINSTALL WHEELS THEN LOWER THE JACK.

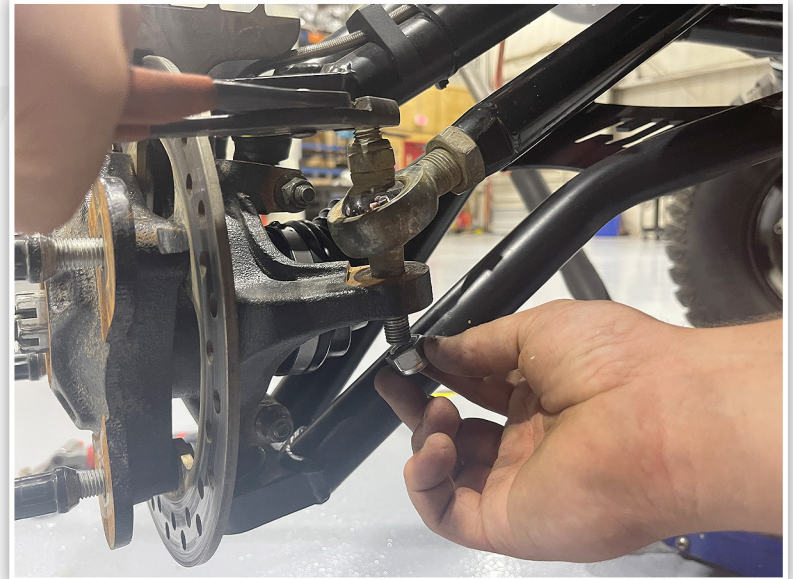
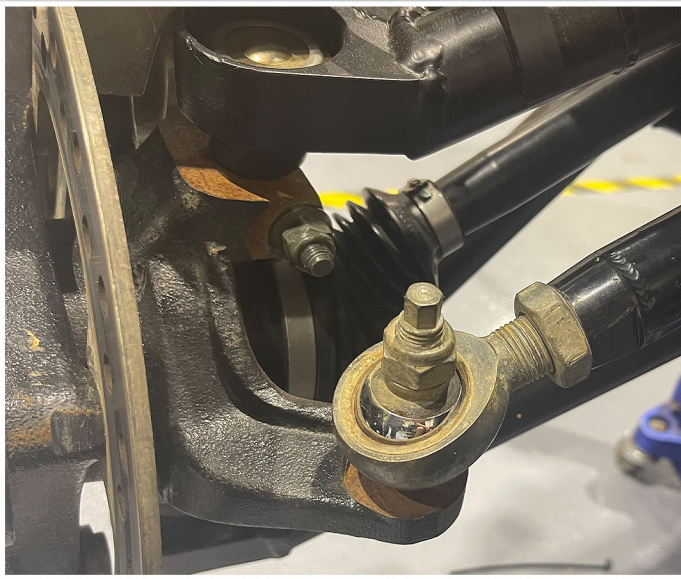

Thank You For Choosing

HIGHLIFTER