

18+ Polaris Ranger XP1000 Heater Kirt
18+ Gravelly Atlas JSV 3400/6400
 ICCH-UD-C-RNGR18XP1000

- 1x 1 1/4" Hole Saw
- 1x 55mm Hole Saw
- 1x Hole Saw Arbor
- 2x #16 Hose Clamps
- 6x #10 Hose Clamps
- 2x #6 Hose Clamps



Standard-9f of 5/8
Heater Hose
Crew -12f of 5/8
Heater Hose

- 1x Blower Switch
- 2x 7/16" Washer
- 2x 5/16-18x5" Bolts
- 2x 5/16x18 Nuts



- 2x 1 1/4" Gommets
- 1x 3-Way Ball Valve



- 1x 1" Brass Y



- 1x Pulse Connector



1x Wiring Harness with
2-Pin Connector



30x 11" Cable Ties

Supplied without Heat Control

- 1x IC-SWBCRED Bezel
- 1x IC-SWBC Bezel
- 1x Switch Nut
- 1x #1 Knob



Supplied with Heat Control

- 1x IC-SWHCBCRED Bezel
- 1x IC-SWHCBC Bezel
- 1x Switch Nut,
- 1x #1 Knobs
- 1x #1 Heat Knob



Heat Control Kit



505



48" 2" Duct Hose
(compressed)

620



1x Heater Unit



1047

IC-POLRANGMHBC18
Main Heater Brkt

1005P



Heater Face Plate with Ports

5x 2" Duct Y's

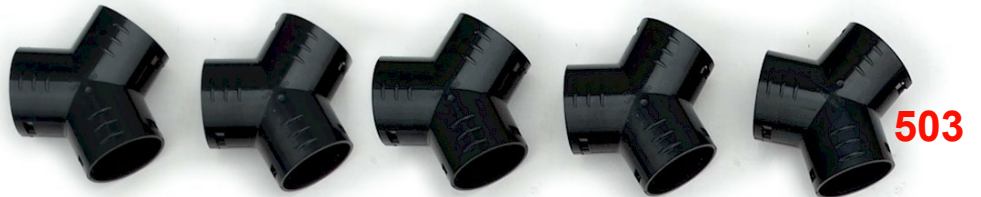

503

8x 2" Vents



501

18+ Polaris Ranger XP1000 Ice Crusher Heater Install Instructions
18+ Gravelly Atlas JSV 3400/6400



Please read all instructions before beginning installation. When working on cooling systems always allow vehicles to cool to avoid being burned or scalded by hot coolant. Always disconnect vehicles negative battery lead before working on electrical systems.

Please note: *Before drilling* any holes check area behind firewall/dash panels to make sure no damage or interference with equipment will occur by drilling holes and fitting of vents.

Please Note: The defrost template is for the non Ride Command option. If you have the Ride Command option then the defrost vent position may need to be altered. Using supplied defrost vent hole template, position templates in the location as shown in Figure 1 and on the template, mark out hole saw centers as stated on template, remove template. Carefully drill holes using supplied 55mm

18+ Polaris Ranger XP1000 Ice Crusher Heater Install Instructions

hole saw as directed on template. **Tip:** Use a knife to remove burrs from the drilled holes to help with fitting of the vents. **Note:** Defrost vents may need to be repositioned because of factory or aftermarket equipment fitment. Scribe through the defrost vent holes to the panel below so the panel can be trimmed as shown in Figures 2a and 2b

Remove seats, drive shaft tunnel panel, gauge cluster dash top, center dash support bracket, and lower right cubby.

Note vent hole positions in dash top as shown in Figures 3a and 3b. Locate the “dimples” on the underside of the dash as shown in Figures 4a and 4b on the left and right side of the dash. Using a 3/16 drill bit drill through the “dimple” to the outside of the dash. Using the supplied 55mm hole saw at the 3/16 holes carefully drill vent holes from the outside of the dash. **Tip:** Use a knife to remove burrs from the drilled holes to help with fitting of the vents.

Using supplied lower vent templates, position template on lower dash panel, tape template into place. Mark out hole centers as stated on template, remove template. Carefully drill holes using supplied 55mm hole saw as directed on templates and as shown in Figures 5a and 5b.

Using supplied heater hose template, position template on the firewall area as shown in Figures 6, tape template into place. Mark out hole centers as stated on template, remove template. Carefully drill holes using supplied 1 1/4 hole saw as directed on template. Fit 1 1/4 Grommets to the drilled holes.

Using supplied switch template, position template to the area as shown in Figure 7, tape template into place. Mark out hole centers as stated on template, remove template. Carefully drill holes using 7/16 drill bit as directed on template.

Fit main heater bracket to heater unit using supplied 5/16"x5" bolts and 5/16 nuts as shown in Figure 9.

Note: If heat control is not supplied with kit, skip all the steps that deal with the heat control unit.

Make up heat control unit as set out in the instructions included with kit. Install on the heater unit as shown in Figures 10a and 10b using supplied 5/8 heater hose and #10 hose clamps.

Using supplied 5/8 heater hose cut 2' from hose. Feed the 2' hose through the upper heater hose grommet from the radiator side of the firewall. Using the remainder of heater hose feed through the lower grommet from the radiator side of the firewall shown in Figure 11. **Tip:** Using dish soap or a rubber/plastic cleaner on the hose will make the hose slip through the grommets easier.

Move heater unit into position under the dash as shown in Figure 12. Remove factory bolt that attaches the firewall plastic to the frame in the area that the heater mounts and refit through the heater mounting bracket into the bolt hole, do not tighten.

18+ Polaris Ranger XP1000 Ice Crusher Heater Install Instructions

Take heater and fit hoses to heater connectors and tighten #10 clamps as shown in Figure 13

Please Note: Be sure to remove factory shipping plugs from heater fittings if so fitted.

Move the heater into position, this will also require pushing some of the heater hose back through the grommets.

Connect the Black 5 Pin Connector to the Switch as shown in Figure 14.

Fit 7/16 washer on to the heater switch and heat control, fit into position as shown in Figure 15a. Fit red then the black switch bezels over the switch and control, install nuts, tighten nut and fit knobs as shown in Figure 15b.

Route the heater plug end of the loom down to the heater connector. Connect the loom connector to the heater connector aligning the locating notches in the plugs as shown in Figure 15c, push the loom connector firmly together. Using the Polaris Pulse Pigtail, connect the two pin connector to the Heater Harness two pin connector. Insert into the Polaris Pulse Panel under the hood.

Using Figure 16 as a guide cut duct hoses to length (**lengths measured with the duct hose in its compressed state, measure and cut accordingly**) Make up hose assemblies using supplied 2" Y connectors as shown in Figure 16. **Tip:** To attach duct hoses to Y's and/or Vents either twist Duct Hose or Vents in a "screw" action. Use cable ties around all duct hose connections.

Fit and route duct hoses as shown in Figures 17a- 17j.

Refit center dash support bracket and tighten up heater mounting bolts. Fit the supplied ¼ Ring terminal to the black loom wire and install under one of the dash support/heater bracket bolt. Reconnect battery, turn key on to check fan operation, disconnect battery. Use cable ties to secure wiring loom.

Drain cooling system by removing lower radiator hose. **Important Tip:** If you have the equipment to clamp off the hoses where the Y fitting is to be installed you won't have to drain cooling system this makes installation much easier.

Route the lower heater hose alongside the coolant pipe in drive shaft tunnel to the rear of the UTV as shown in Figure 18. Route to the right side of the engine to the bypass hose shown in Figures 19b.

Using Figures 19a and 19b as a guide, cut the Oil Cooler Bypass Hose as shown in Figure 19b, removing approximately 1" to 1.5" of the hose. As of July, 2022 the Polaris Ranger kit has been upgraded to include a custom 3-Way Ball Valve that will greatly improve the heater performance. Insert the 3-Way Valve as shown in Figure 19c, and secure using #10 Hose Clamps on either End. Cut the 5/8" Heater Hose to length and install on the 3-Way Valve. Secure it using a #10 Hose Clamp

Locate the lower radiator hose at the front of the UTV as shown in Figure 20a. Using Figures 20a and 20b as a guide, cut 1" to 1.5" of the radiator hose and insert the 1" Brass Y as shown in Figure 20b. Secure the ends with #16 Hose Clamps. Cut the 5/8" Heater Hose to length if necessary, insert it over the 5/8" Barb and secure it with a #10 Hose Clamp.

18+ Polaris Ranger XP1000 Ice Crusher Heater Install Instructions

Please Note: Make sure all hoses are as far away as possible from driveshaft, steering shaft, sharp objects and the exhaust system etc. When routing the hoses make sure that hoses make nice sweeping bends so as not to cause any kinking of the hoses. Use supplied cable ties as necessary to secure hoses.

Important: Refill cooling system as per manufacturer's procedure. Reconnect battery. Start and run the vehicle at a fast idle and run up to normal operating. Check for leaks. Check operation of heater.

Reassemble UTV as required.

Allow vehicle to cool and recheck cooling system level and coolant ratio, fill as required. Refill cooling system as per manufacturer's procedure. Start and run the vehicle at a fast idle and run up to normal operating temperature. Check for leaks. Check heater operation. Allow vehicle to cool and recheck cooling system level and coolant ratio, fill and/or alter coolant ratio as required. Repeat this procedure until the heater produces reliable heat. Please Note: Heater output will be limited at idle, all testing should be done at fast idle.

Caution: When working on cooling systems always allow vehicles to cool before opening radiator cap to avoid being burned or scalded by hot coolant.

IMPORTANT NOTE FOR OPTIONAL IN CAB HEAT CONTROL: AT THE END OF THE COOLER MONTHS WHEN THE HEATER IS NO LONGER DESIRED TO PRODUCE HEAT, IT IS IMPORTANT TO TURN THE 3-WAY BALL VALVE HANDLE SUCH THAT IT IS PARALLEL WITH THE OIL COOLER BYPASS LINE. THIS WILL DIVERT COOLANT BACK TO THE ENGINE IN THE EVENT THAT THE IN CAB HEAT CONTROL KNOB IS IN THE OFF POSITION, WHICH WILL CAUSE THE COOLANT IN THE OIL COOLER BYPASS LINE NOT TO MOVE.



OFF (SUMMER)



ON (WINTER)

18+ Polaris Ranger XP1000 Ice Crusher Heater Install Instructions



Figure 1

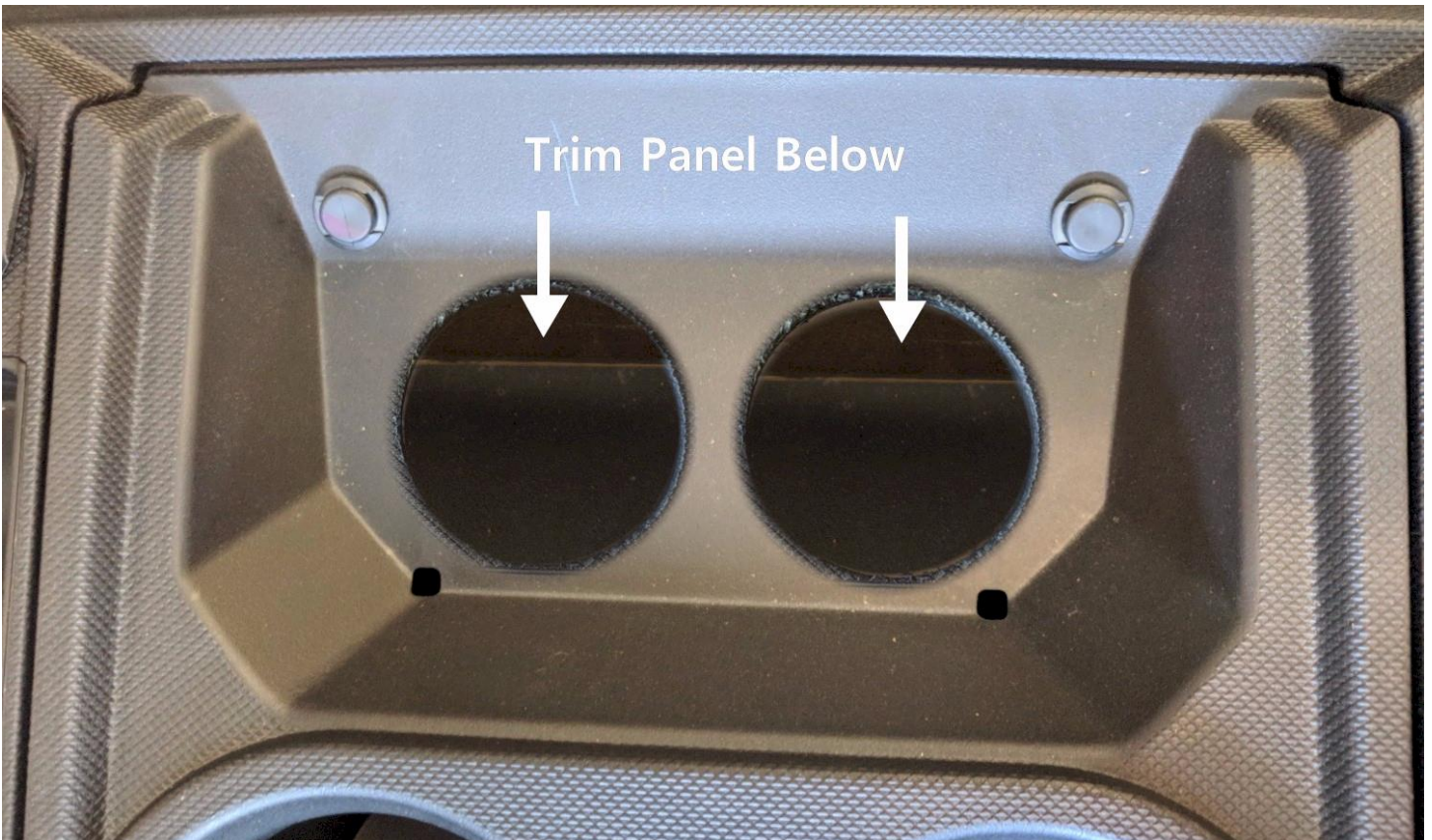

Figure 2a

18+ Polaris Ranger XP1000 Ice Crusher Heater Install Instructions

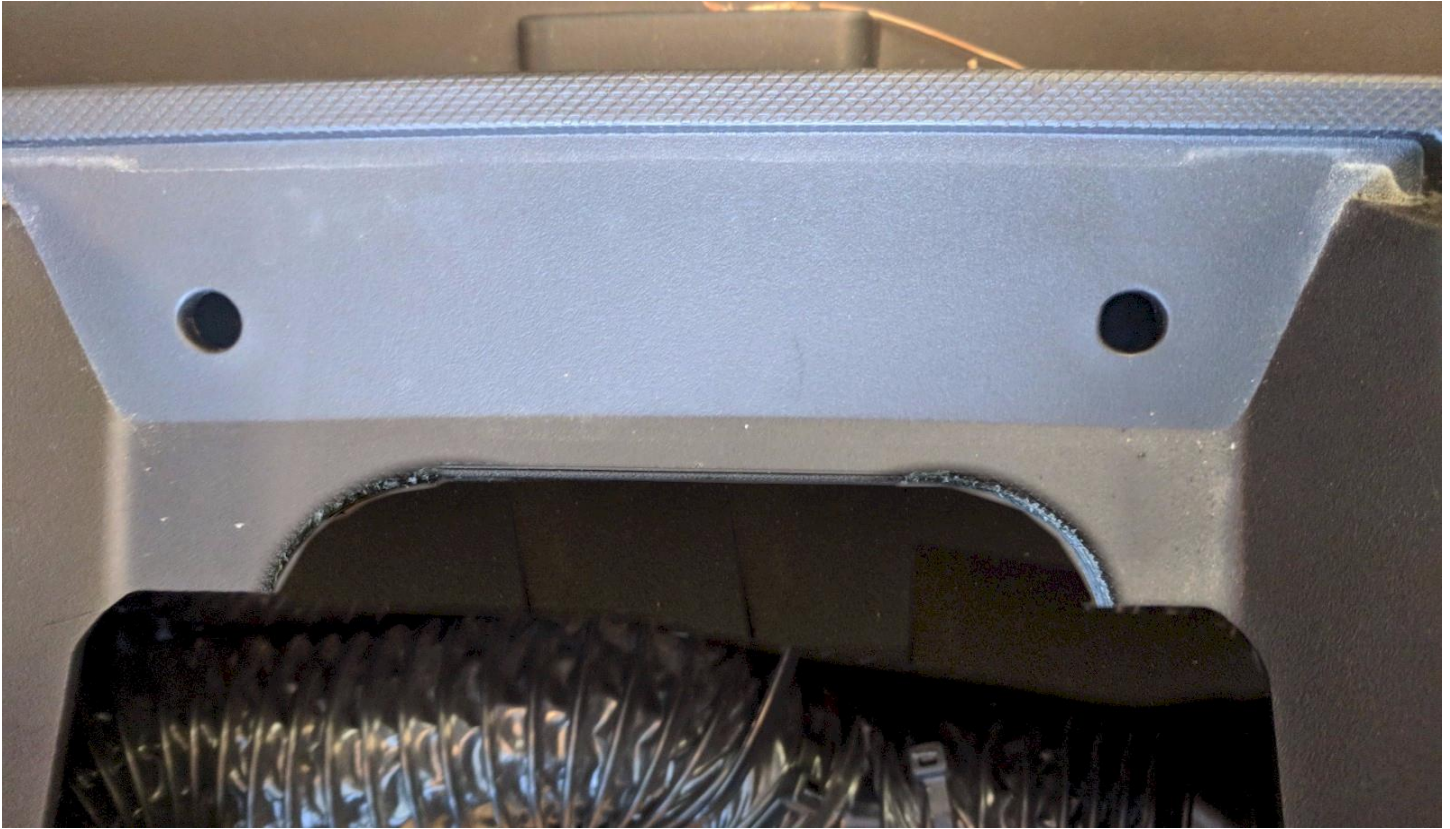

Figure 2b



Figure 3a

18+ Polaris Ranger XP1000 Ice Crusher Heater Install Instructions



Figure 3b



Figure 4a

18+ Polaris Ranger XP1000 Ice Crusher Heater Install Instructions



Figure 4b

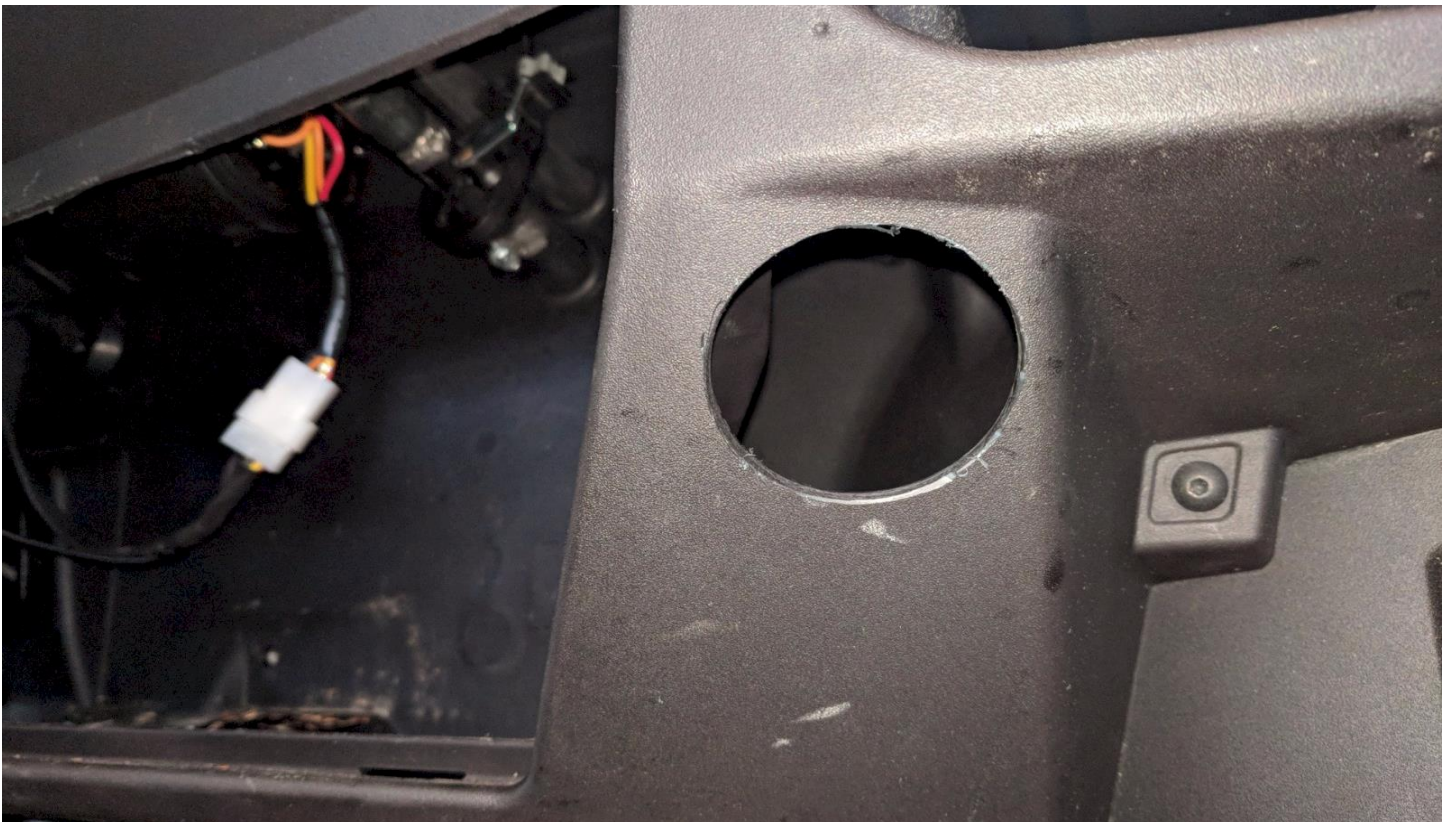

Figure 5a

18+ Polaris Ranger XP1000 Ice Crusher Heater Install Instructions



Figure 5b



Figure 6

18+ Polaris Ranger XP1000 Ice Crusher Heater Install Instructions

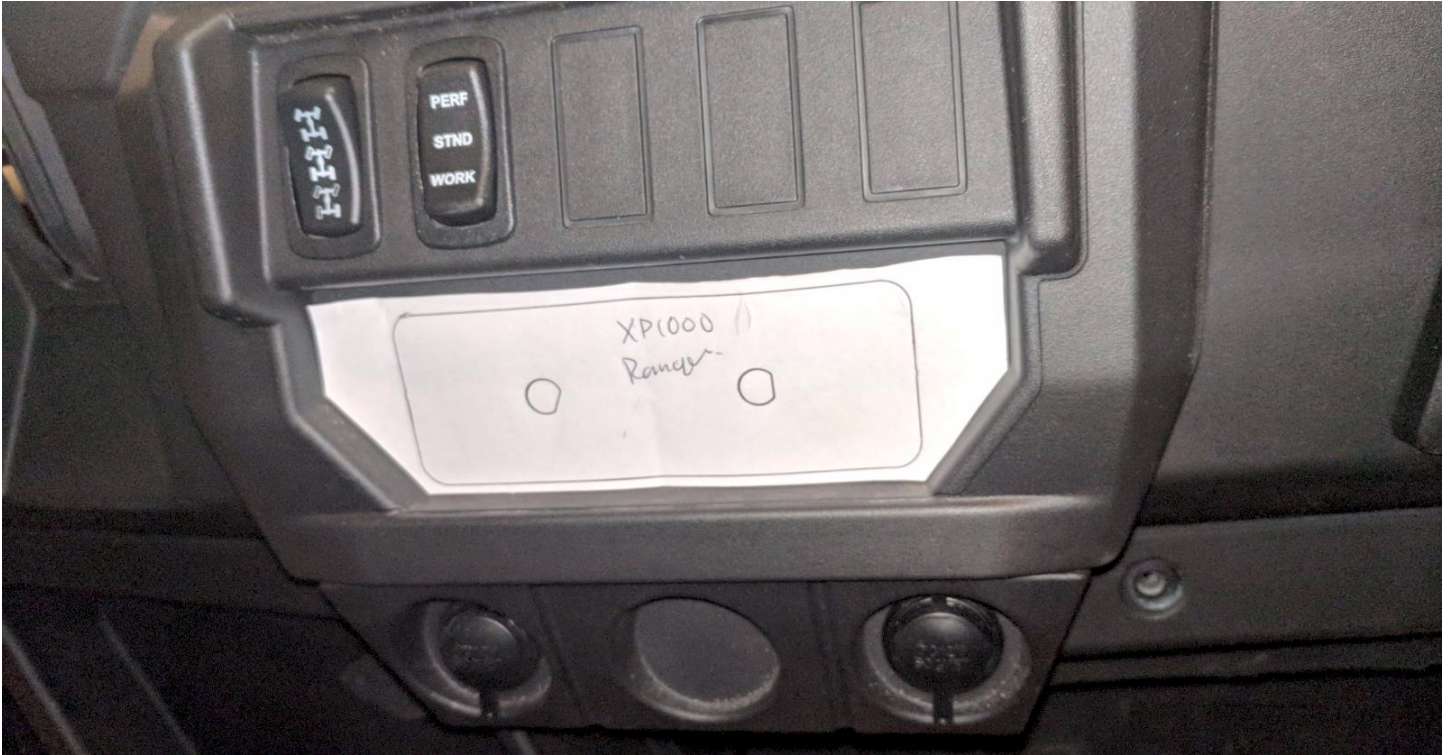

Figure 7

18+ Polaris Ranger XP1000 Ice Crusher Heater Install Instructions



Figure 9

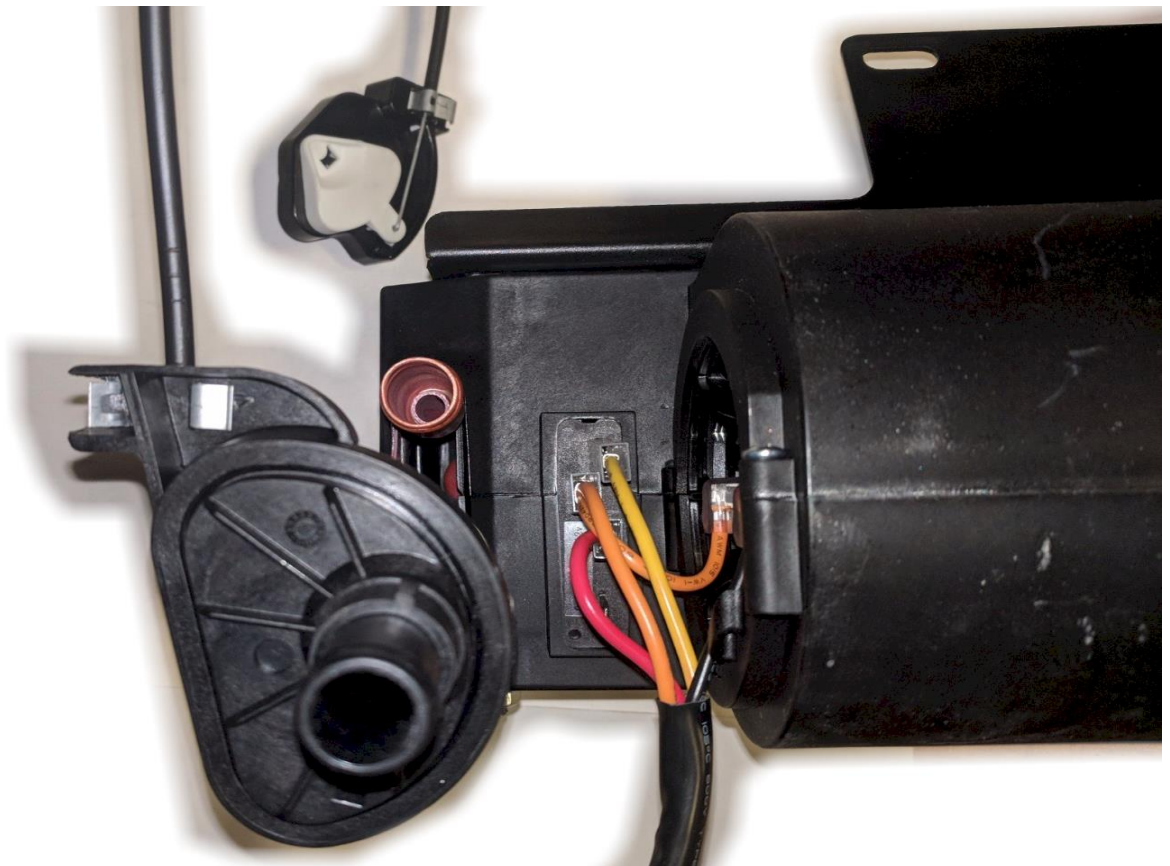

Figure 10a
ICCH-UD-C-RNGR18XP1000

18+ Polaris Ranger XP1000 Ice Crusher Heater Install Instructions

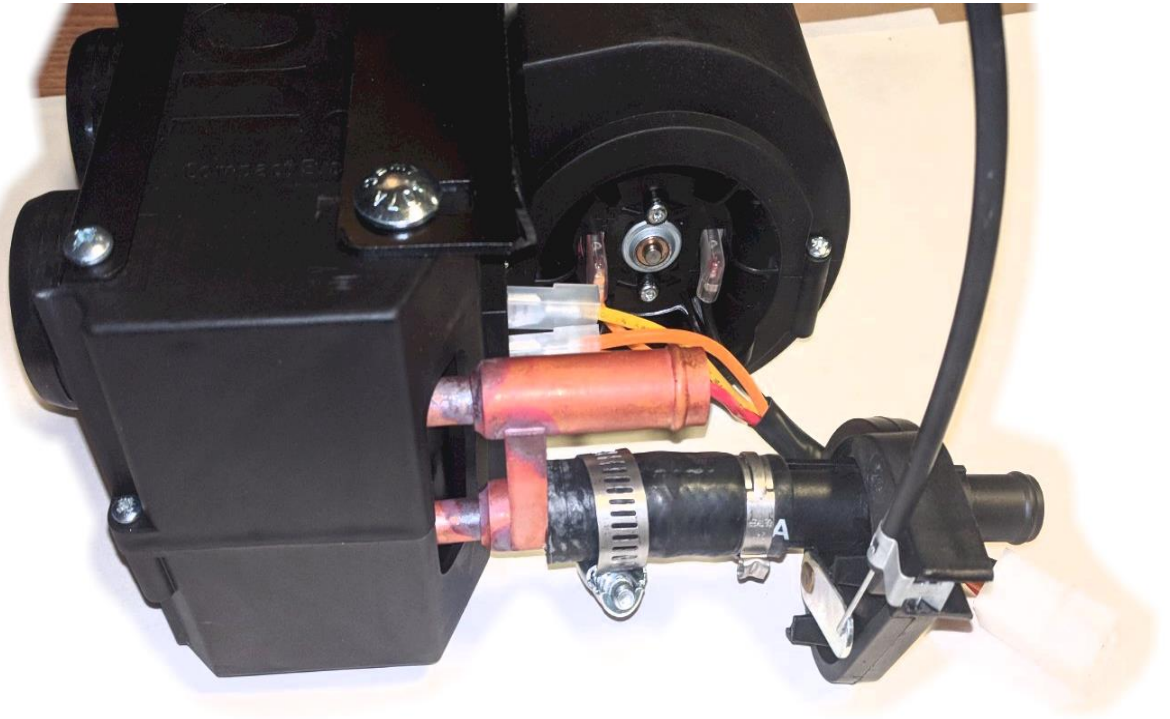

Figure 10b



Figure 11

18+ Polaris Ranger XP1000 Ice Crusher Heater Install Instructions



Figure 12

18+ Polaris Ranger XP1000 Ice Crusher Heater Install Instructions



Figure 13

18+ Polaris Ranger XP1000 Ice Crusher Heater Install Instructions

Image Remove

Figure 14

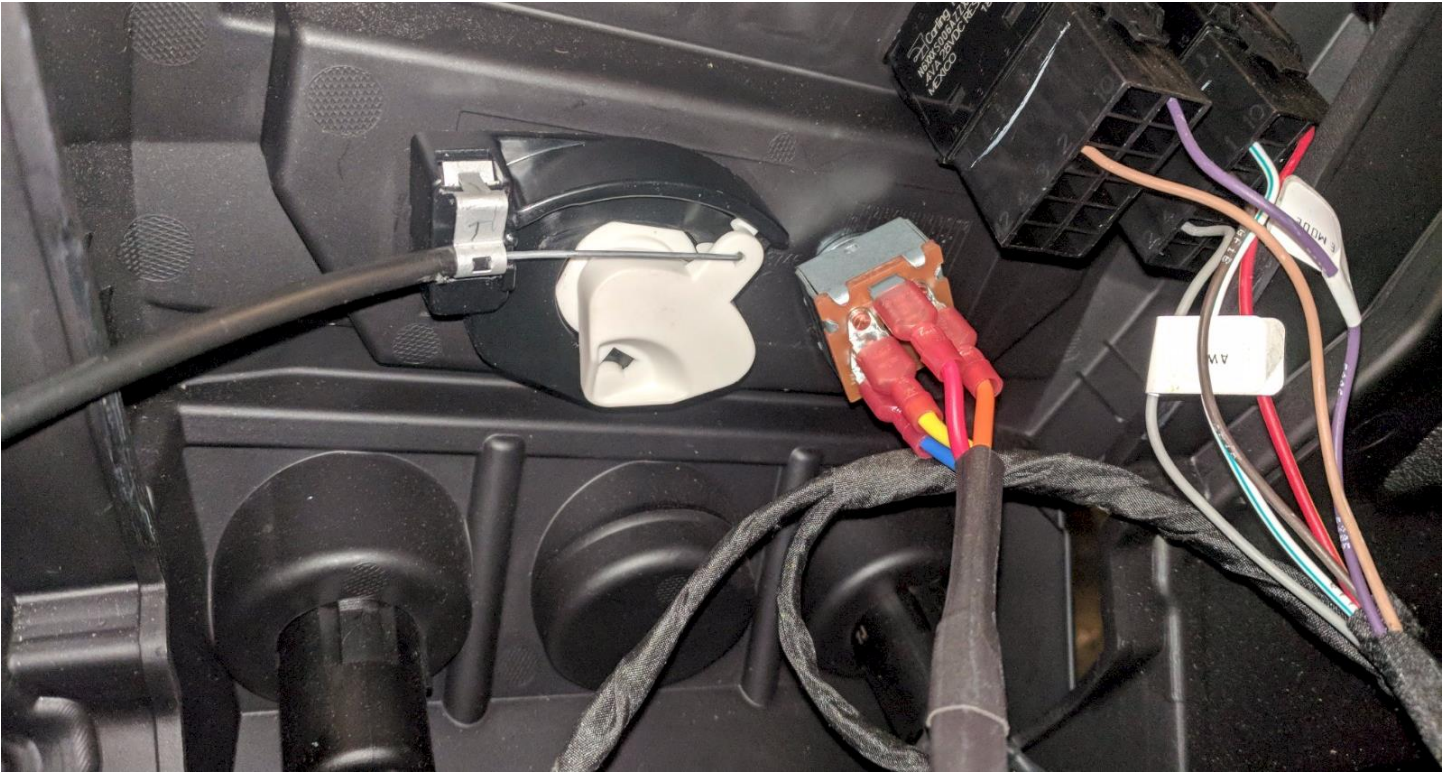

Figure 15a

18+ Polaris Ranger XP1000 Ice Crusher Heater Install Instructions



Figure 15b

**Align Connector
Plugs Locating
Notches**

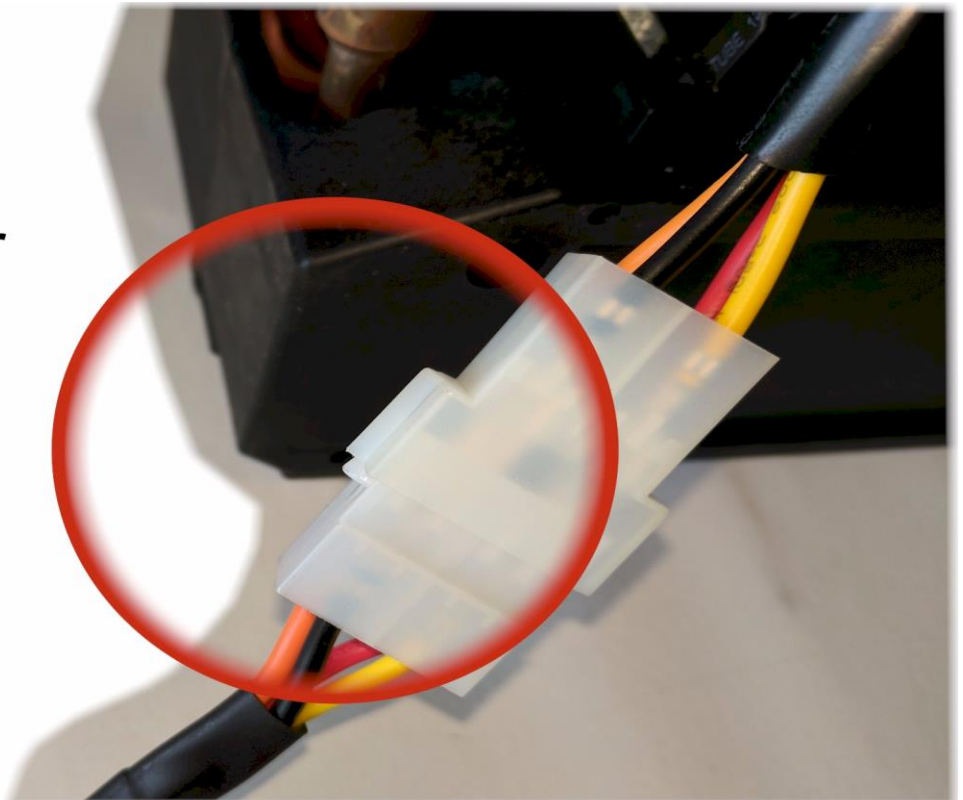

Figure 15c

18+ Polaris Ranger XP1000 Ice Crusher Heater Install Instructions

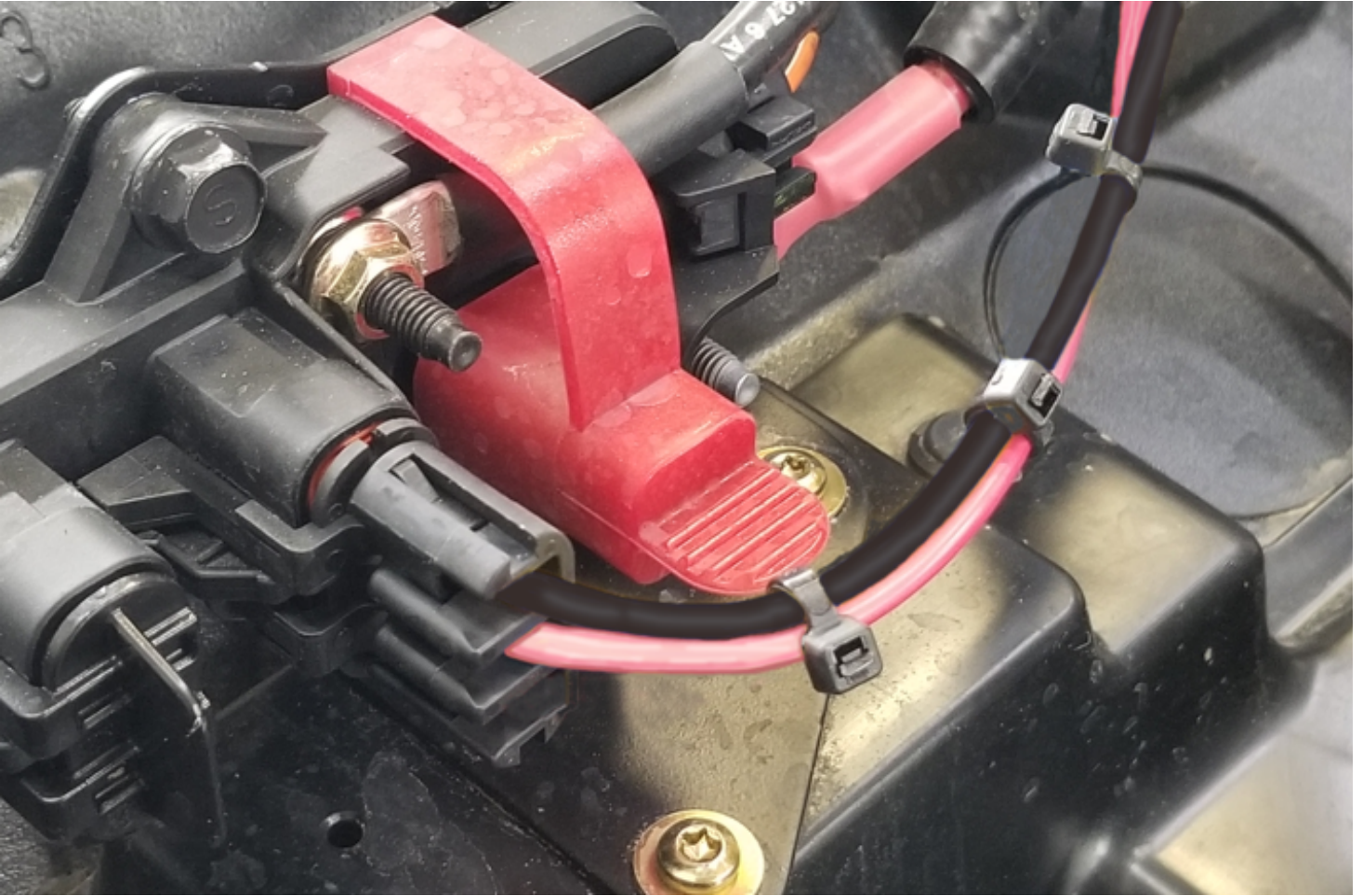

Figure 15d

18+ Polaris Ranger XP1000 Ice Crusher Heater Install Instructions

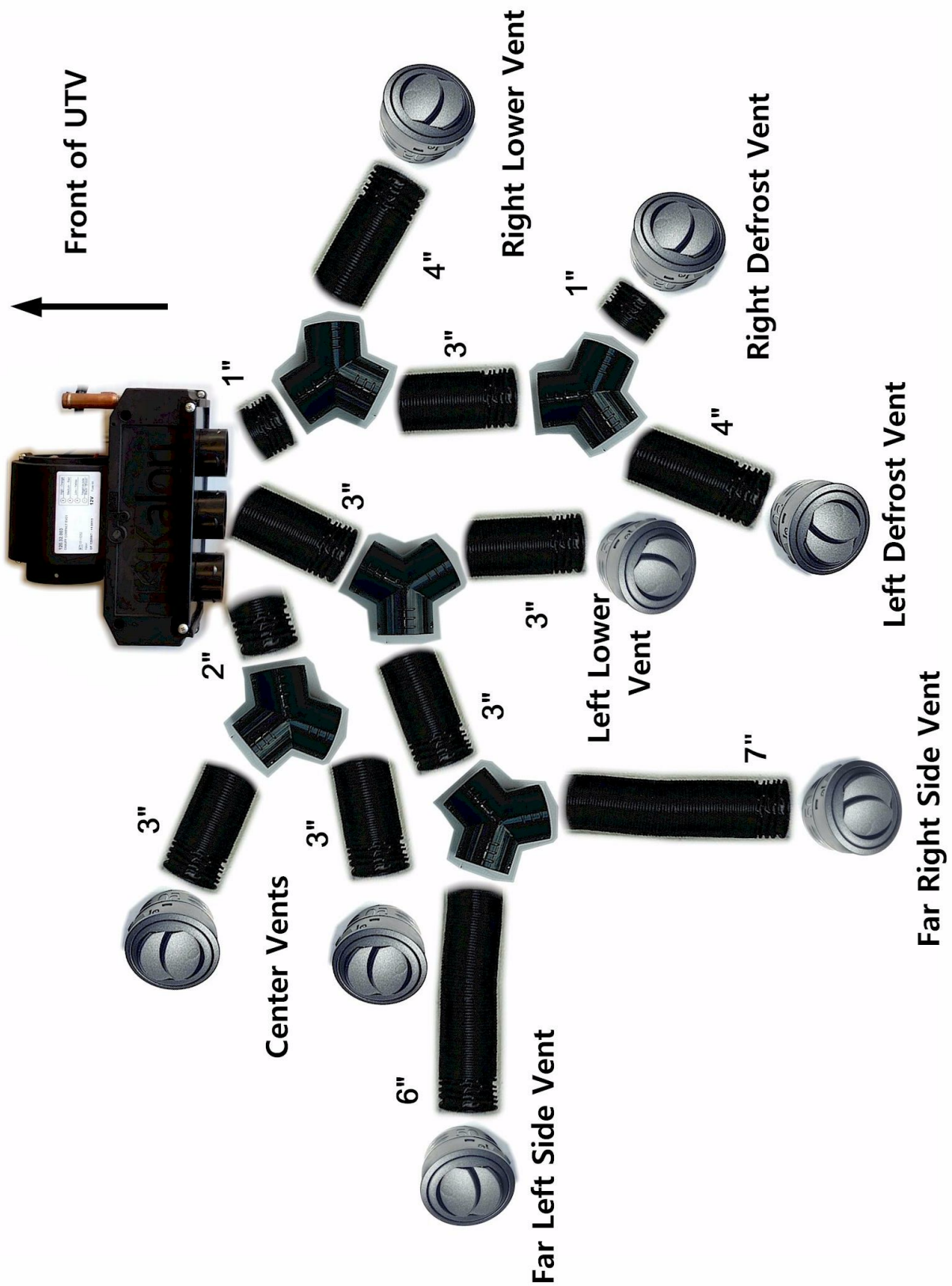

Figure 16
ICCH-UD-C-RNGR18XP1000

18+ Polaris Ranger XP1000 Ice Crusher Heater Install Instructions

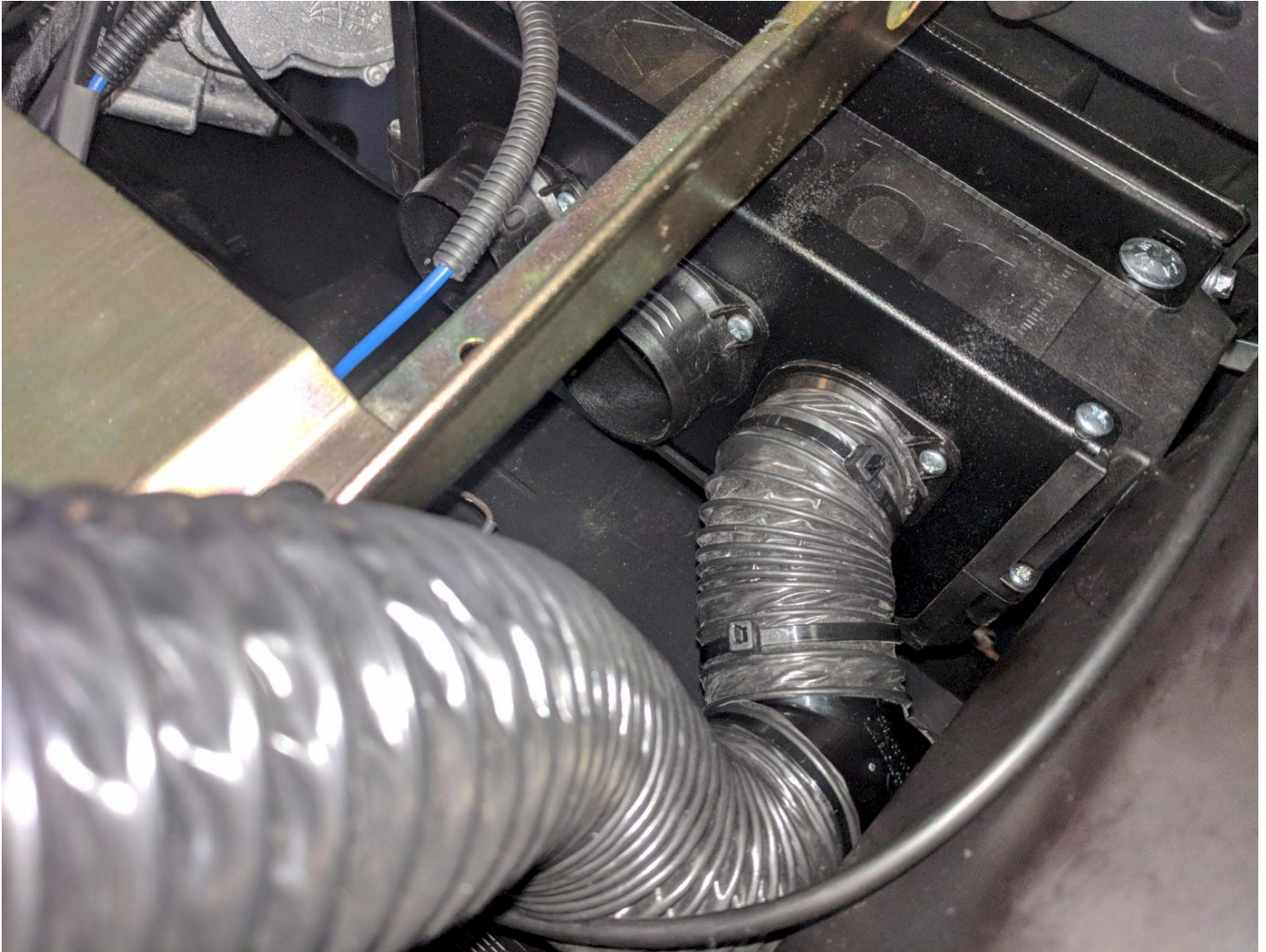

Figure 17a



Figure 17b

18+ Polaris Ranger XP1000 Ice Crusher Heater Install Instructions

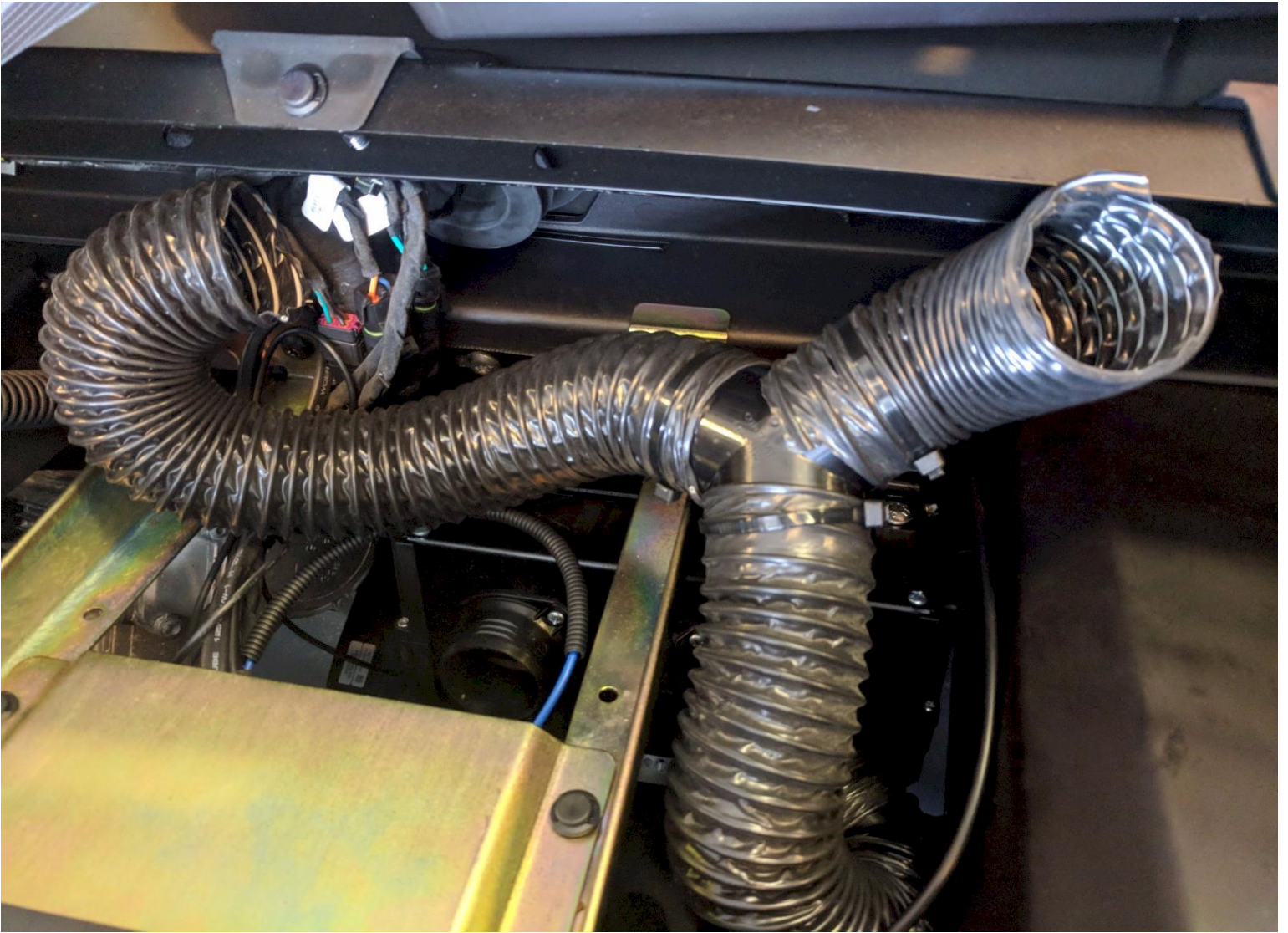

Figure 17c

18+ Polaris Ranger XP1000 Ice Crusher Heater Install Instructions



Figure 17d



Figure 17e

18+ Polaris Ranger XP1000 Ice Crusher Heater Install Instructions



Figure 17f

18+ Polaris Ranger XP1000 Ice Crusher Heater Install Instructions



Figure 17g

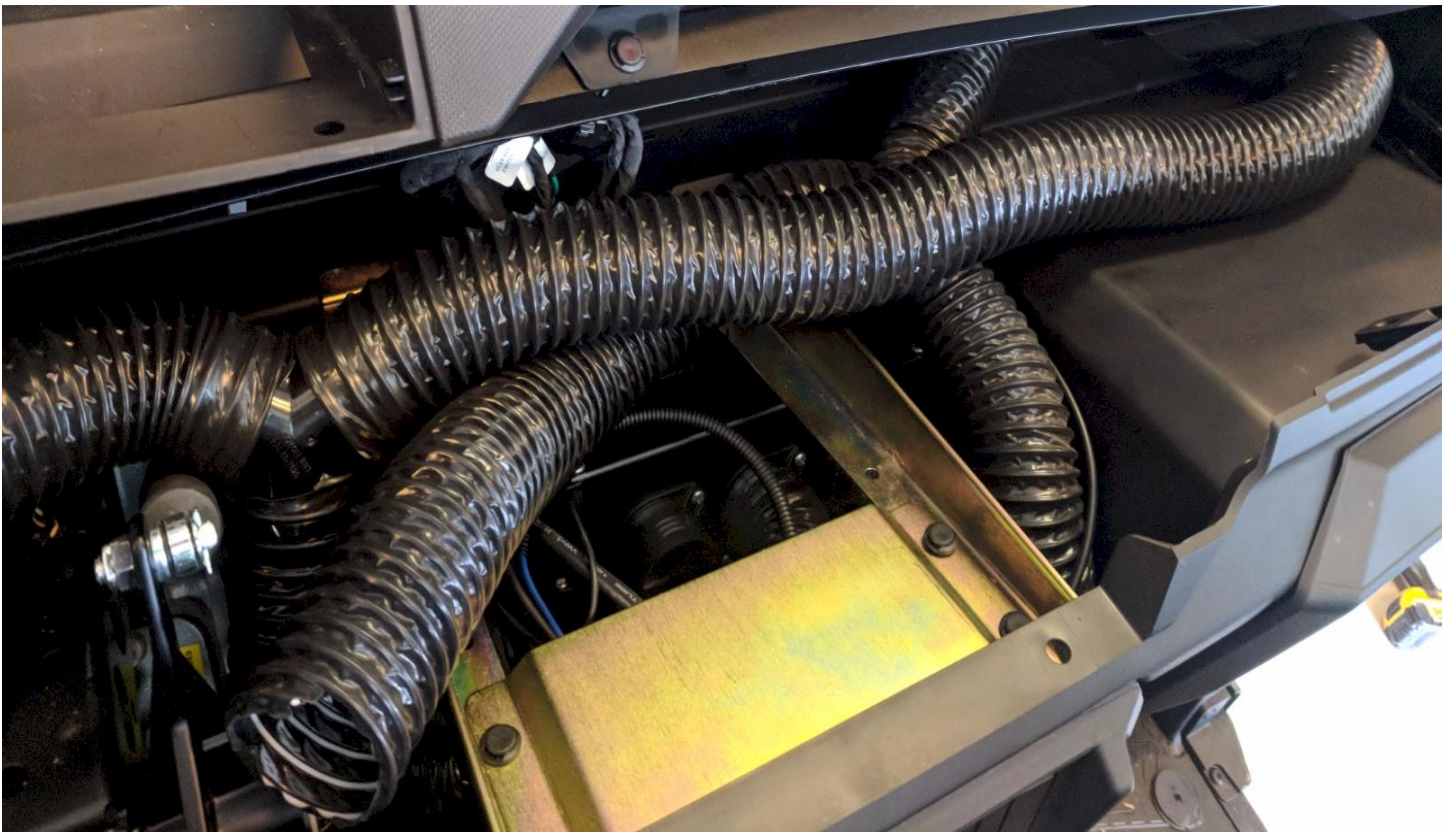

Figure 17h

18+ Polaris Ranger XP1000 Ice Crusher Heater Install Instructions



Figure 17i



Figure 17j

18+ Polaris Ranger XP1000 Ice Crusher Heater Install Instructions



Figure 18

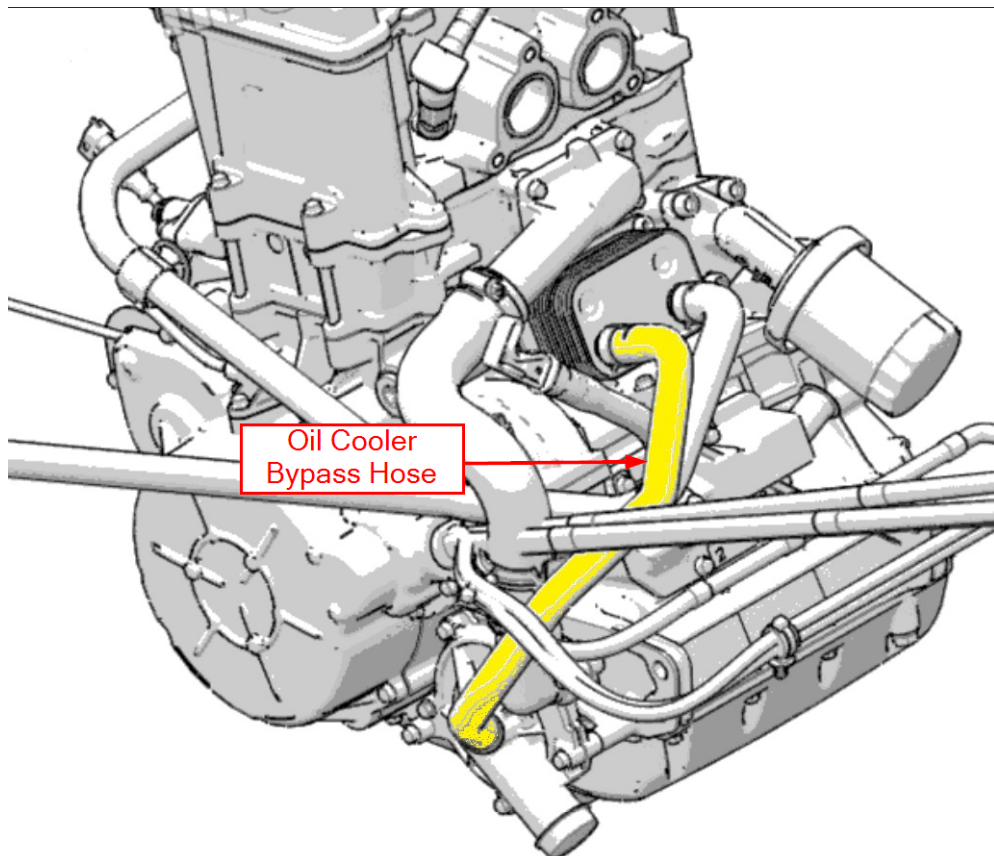

Figure 19a

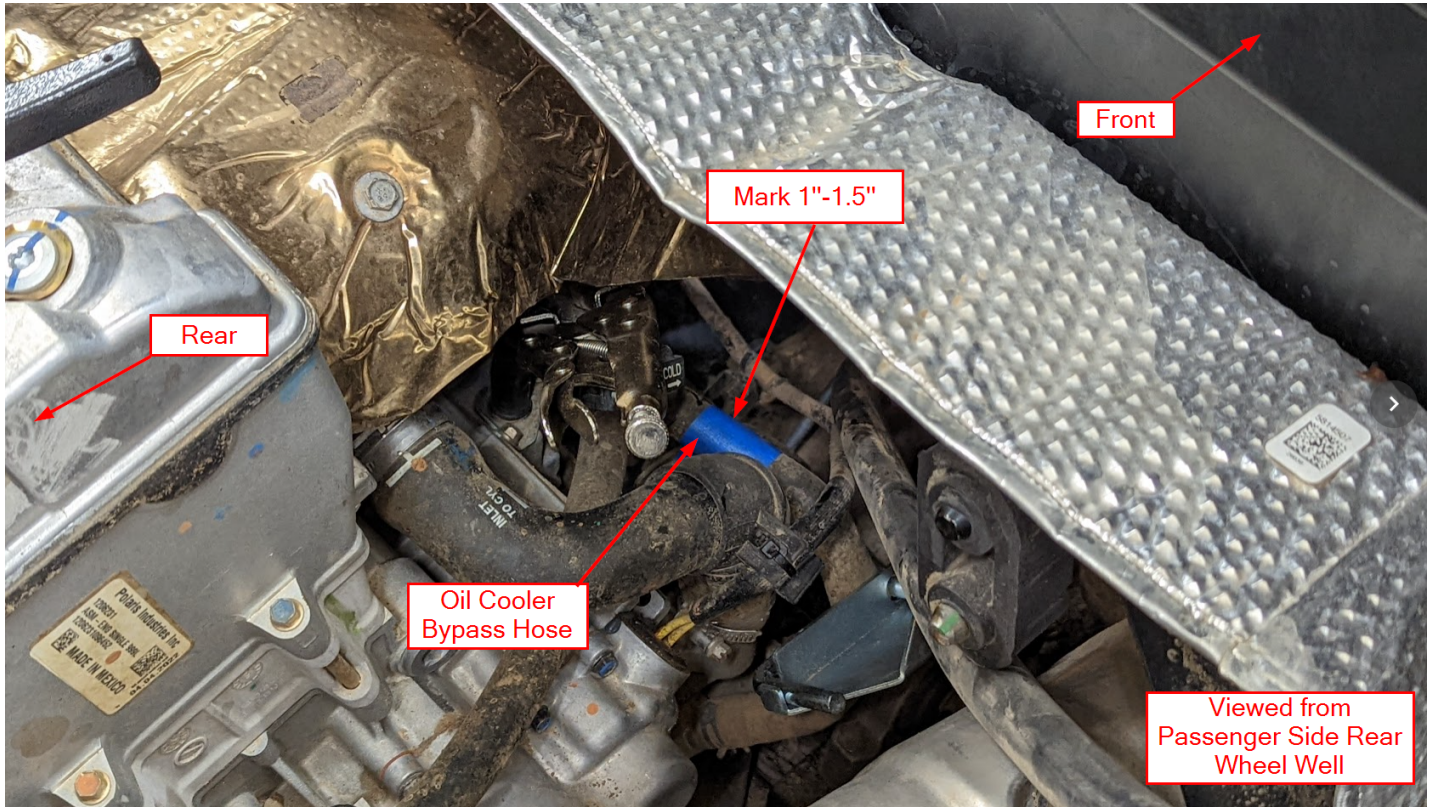

Figure 19b

As of July 13, 2022 the Polaris Ranger XP1000 kit has been upgraded to include a 3-Way ball valve that takes the place of the 1/2" Aluminum Y Fitting shown in the below picture. The 3 Way Valve will greatly improve heater performance and has an arrow indicating the flow direction. Align the Arrow with the flow direction arrows shown in the picture below. In winter months, turn the handle perpendicular to the valve to direct coolant flow through the heater. In the spring or summer, rotate the handle parallel with the body to shutoff coolant flow to the heater.

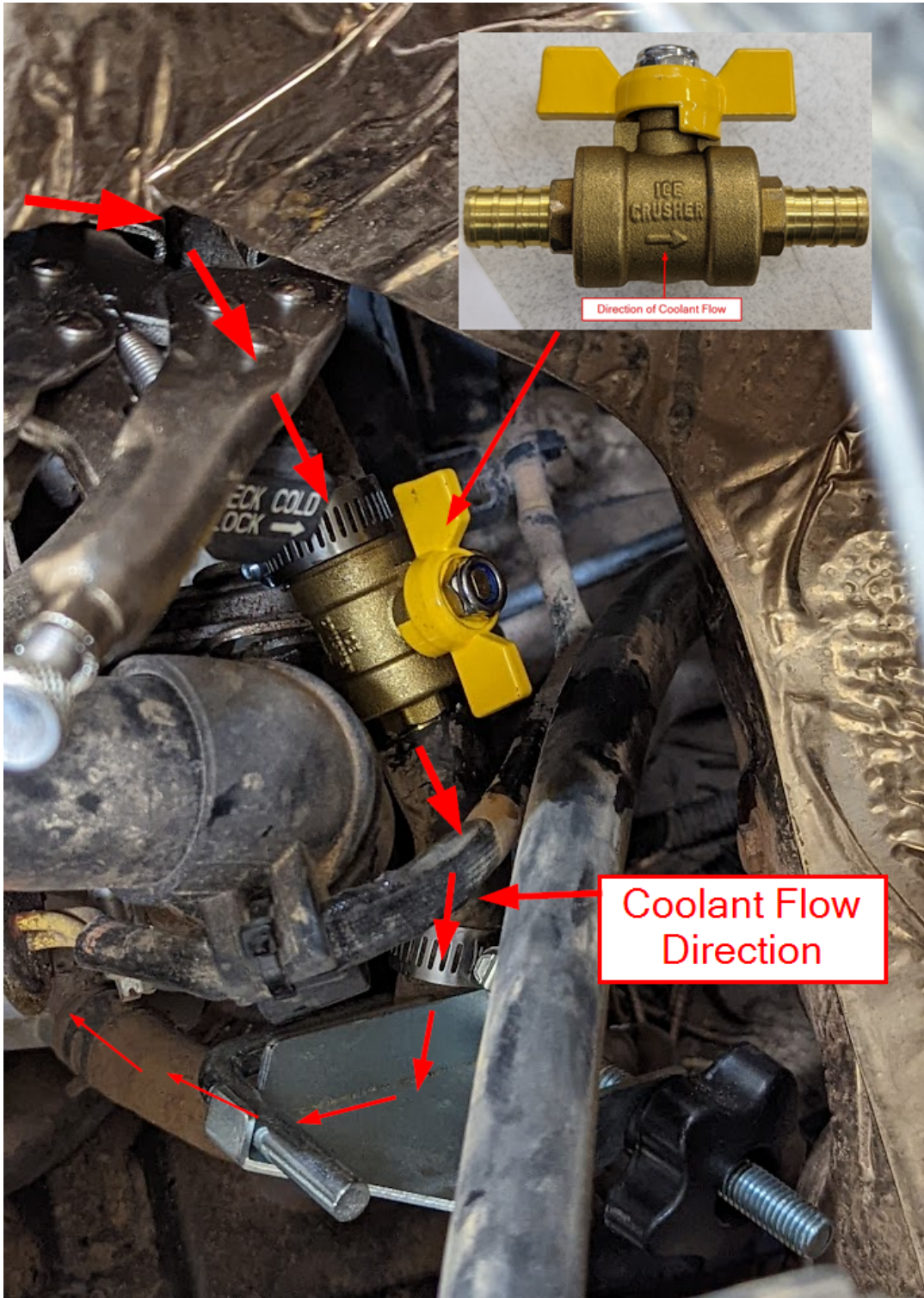

Figure 19c (Updated 2022.07.13)

18+ Polaris Ranger XP1000 Ice Crusher Heater Install Instructions



Figure 20a



Figure 20b

18+ Polaris Ranger XP1000 Ice Crusher Heater Install Instructions

HEATER WARRANTY – utvheaters.com and couperproducts.com

***Couper's Products/UTV Heaters.com Heater Warranty. 3 Year/36 Month Limited Warranty**

Couper's Products warrants your UTV Heater System to be free from defects in material and craftsmanship under normal use and service by the original consumer purchaser (end user) for a period of Three (3) year from the date of purchase on all components except electrical components including but not limited to, motor, switch, wiring and resistor. Electrical components are warranted to be free from defects in material and craftsmanship under normal use and service by the original consumer purchaser for a period of One (1) year from the date of purchase. The warranty is null and void if the system has been damaged by accident, improper installation, unreasonable use, lack of proper maintenance, unauthorized repairs or modifications, or causes not arising from defects in materials and craftsmanship.

Couper's Products obligation under this warranty are limited to repair of the product at Couper's Products production facility, or the replacement of the product at Couper's Products option and at Couper's Products expense. Any expense involved *in the removal, reinstallation, or transportation of the product is **not** covered by this warranty.* Prior to return of any product to Couper's Products customer must contact Couper's Products customer service, (802) 294 0016, and obtain a Return Authorization Number. This number must be marked on exterior of carton for easy identification. Warranty product received at Couper's Products without a Return Authorization Number may be returned at expense of sender.

Postage must be prepaid, and the original dated proof-of-purchase must be included. Couper's Products will not be liable for any damages sustained in transport due to improper packaging or handling. The acceptance by Couper's Products of any product returned shall not be deemed as an admission that the product is defective or in any violation of any warranty.

This warranty is Couper's Products only express warranty of this product. We reserve the right to make changes to products and policy that are in the best interest of Couper's Products. No implied warranty shall extend beyond One (1) or Three (3) year period from the date of the original consumer (end user) purchase. Couper's Products will not be liable for any damages, for loss of use of this product, nor for any consequential damages, costs or expenses.

Some states do not allow limitations on how long an implied warranty lasts or the exclusion of incidental or consequential damages, so the above limitations and exclusions may not apply to you. This warranty gives you specific legal rights and you may also have other rights not mentioned here that vary from state to state.

After receiving a Return Authorization Number send defective product to:

Ice Crusher Heaters

Attn: Warranty

23001 Industrial Blvd,

Rogers, MN, 55374

Mark hole centers
and drill hole with
55mm hole saw

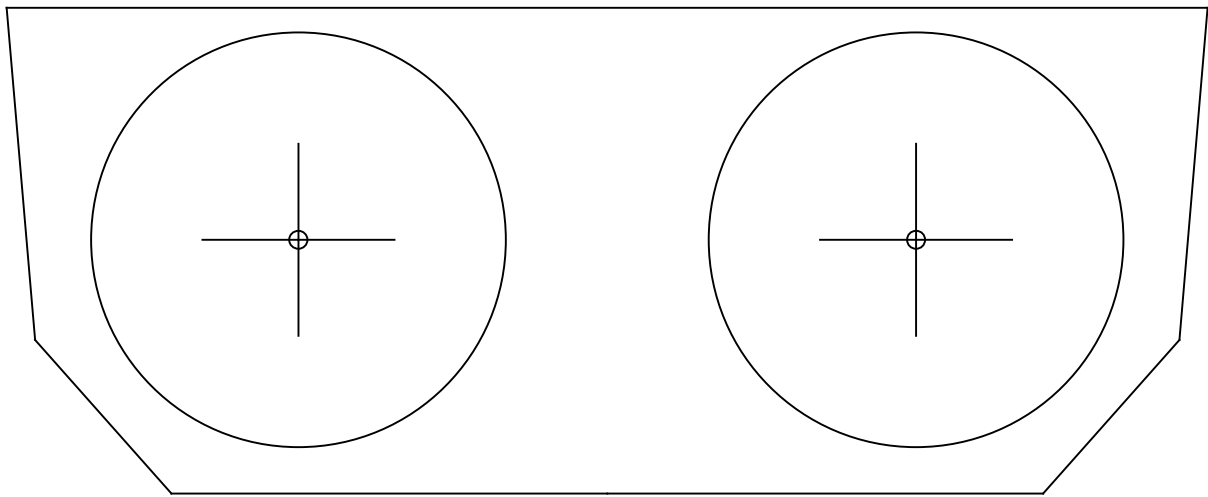

Center Vents Template as
shown in Figure 1 and 2a

Please note: Before drilling any holes check area
behind firewall/dash panels to make sure no
damage or interference with equipment will occur by
drilling holes and fitting of vents.

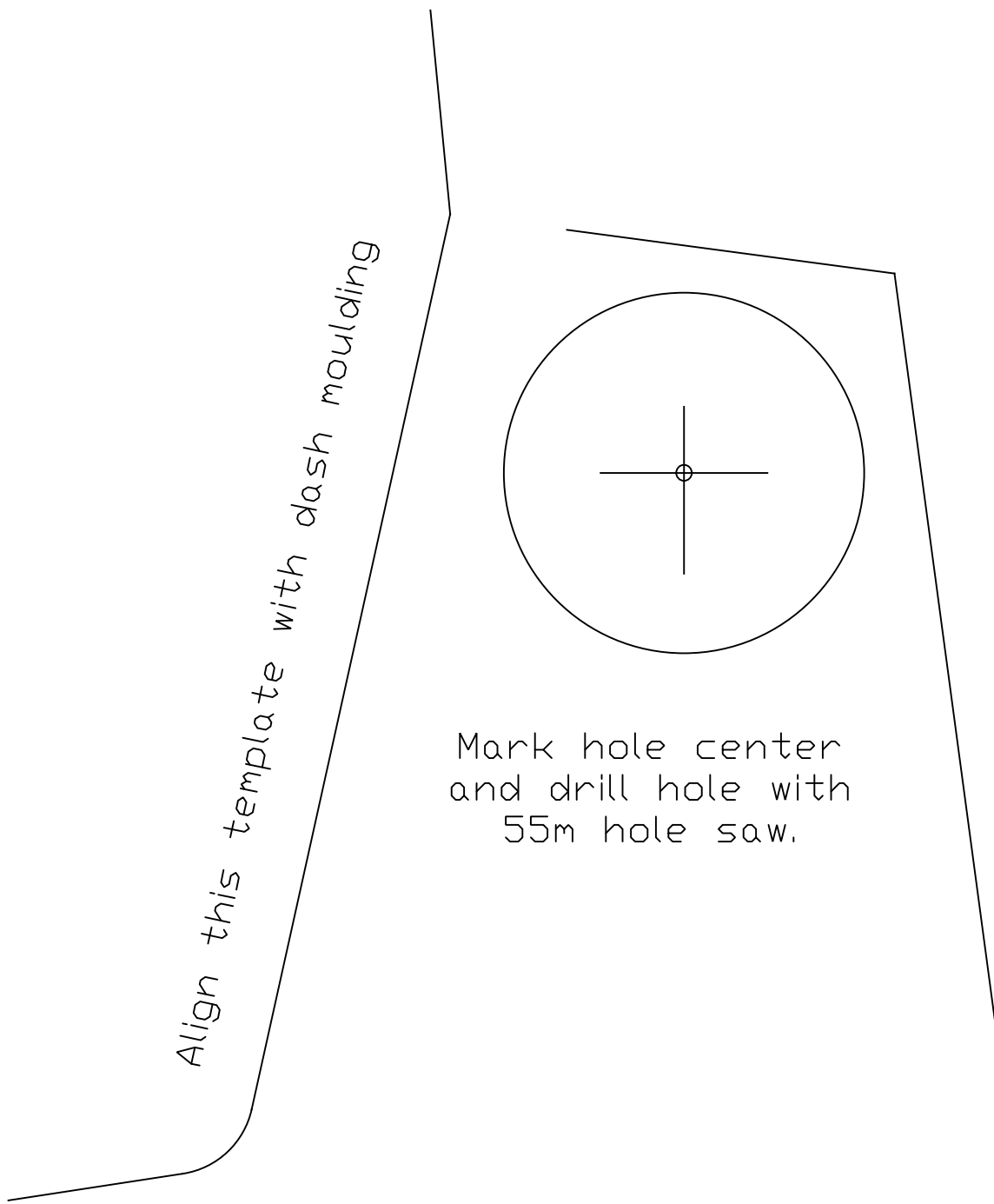

Lower Right Vent Template as shown in Figure 5a

Please note: Before drilling any holes check area behind firewall/dash panels to make sure no damage or interference with equipment will occur by drilling holes and fitting of vents and hoses.

Lower Left Vent Template as shown in Figure 5b

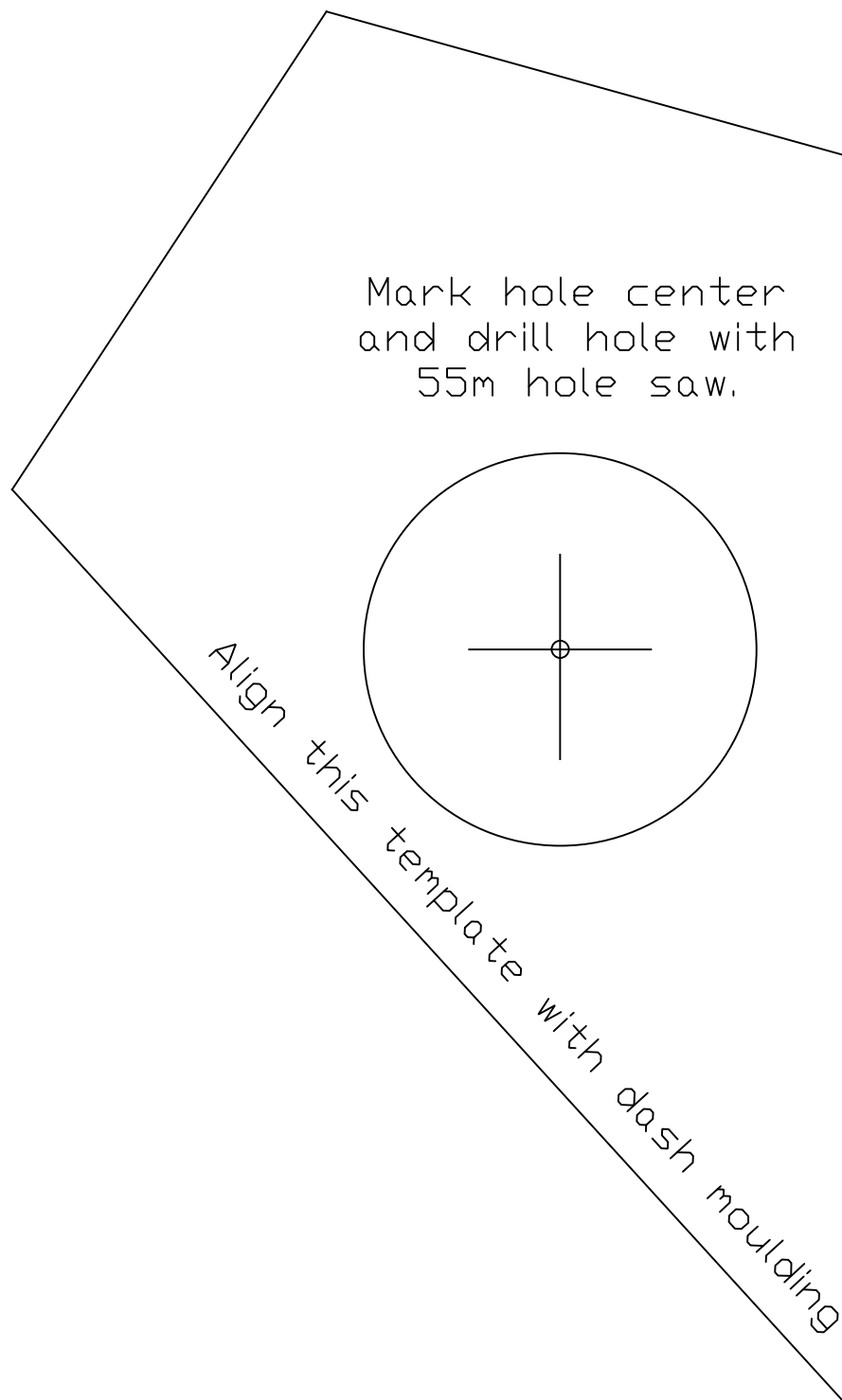

Please note: Before drilling any holes check area behind firewall/dash panels to make sure no damage or interference with equipment will occur by drilling holes and fitting of vents and hoses.

Switch and Heat Control Template as shown in Figure 7

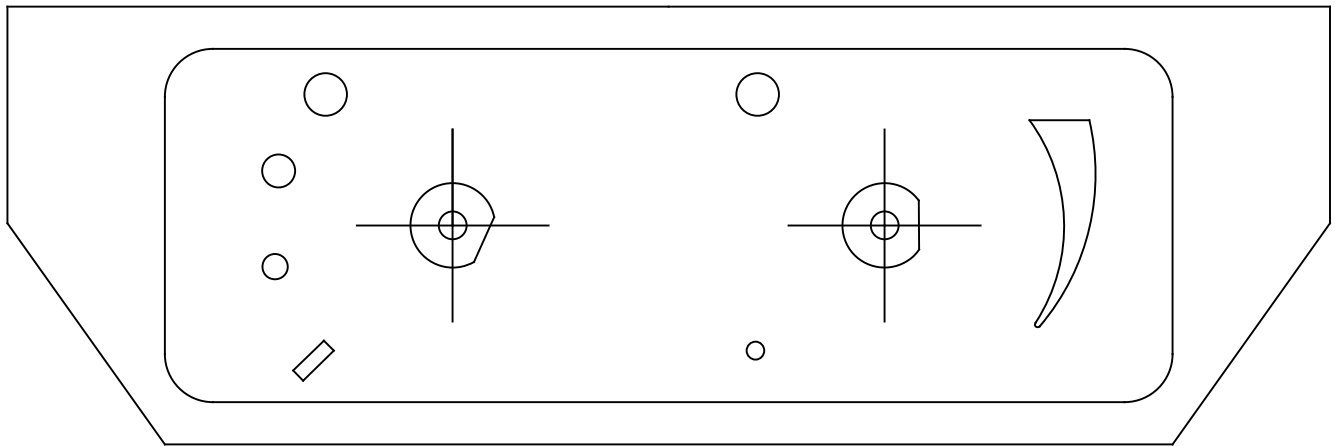

Align this template with dash moulding

Mark hole centers and drill holes with
7/16" drill bit. If no heat control mark
and drill only switch hole.

Align this line with firewall moulding

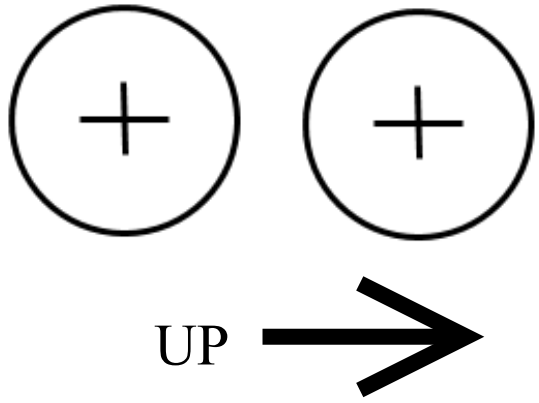

Mark hole centers
and drill hole with
1 1/4" hole saw

Heater Hose Template as shown in Figure 6

Please note: Before drilling any holes check area behind firewall/dash panels to make sure no damage or interference with equipment will occur by drilling holes and fitting of vents and hoses.

Align this edge with panel
moulding