

Can Am Commander/Maverick 1000

Limited Heater Kit

ICGH-UD-C-CANCOM1000LTD or ICGH-UD-C-CANMAV1000LTD

1x 1 1/4" Hole Saw
1x 55mm Hole Saw
1x Hole Saw Arbor



4x #16 Hose Clamps



6x #10 Hose Clamps



1x Blower Switch



1x 7/16" Washer



5x 1/4" Fender Washers



2x 5/16-18x5" Bolts



2x 5/16x18 Nuts



6x #8x1/2" Screws



4x 1/4-20x3/4" Bolts



2x 1/4-20x1" Bolt



6x 1/4x20 Nuts



3x 1/4" Push-Pins



2x 1 1/4" Gommets



2x - 1" Brass Y's



1x 1/4" Eye Terminal
1x Quick Connectors



1x 5/8 Shut Off Valve



1x Round Bezel
1x #1 Knob
1x Switch Nut



9f of 5/8
Heater Hose



1x Pre-made Power Loom



30x 11" Cable Ties

1079

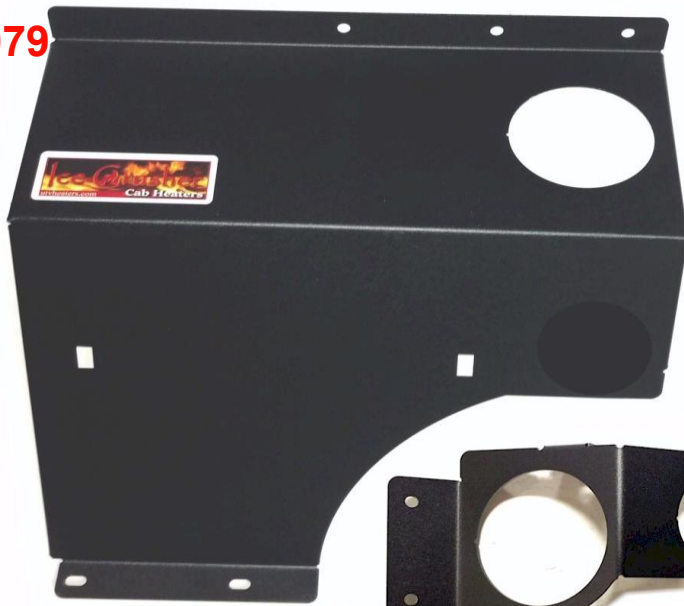

2x Heater Brackets

1080

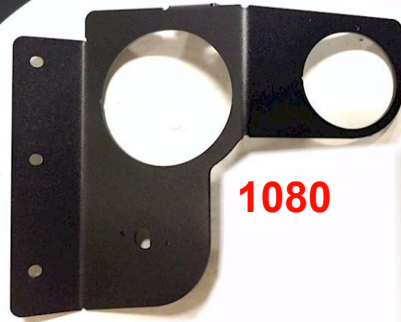

620



1x Heater Unit

1005

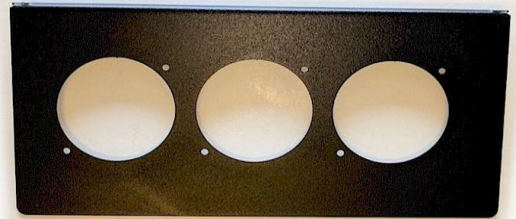

1x IC-KFPC Face Plate

2x 2" Duct Ys



503

2x 3" Vents



502

3x 2" Vents



501

3x 50mm Connectors



500

505



34" 2" Duct Hose
(compressed)

ICE CRUSHER HEATERS

Please read all instructions before beginning installation. When working on cooling systems always allow the vehicle to cool to avoid being burned or scalded by hot coolant. Always disconnect vehicle's negative battery lead before working on electrical systems. This kit is reasonably complex to install. Competent mechanical skills are required.

Please note: *Before drilling* any holes check area behind firewall/dash panels to make sure no damage or interference with equipment will occur by drilling holes and fitting of vents, hoses, wiring etc.

Tip: Use a knife to remove burs from the drilled holes.

Use supplied defrost vent hole templates in the correct position as shown in Figure 1. Mark out hole saw centers as stated on template. Flip over templates to mark out the opposite side. Carefully drill holes using supplied 55mm hole saws as directed on template. **Tip:** Use a knife to remove burs and chamfer from the drilled holes to help with fitting of the vents.

Remove the two factory bolts that attach the floor board to the firewall on the RH side below the glove box as shown in Figure 2a. Using supplied heater mounting bracket, hold bracket up into position as shown in Figure 2b (use bare bracket with nothing attached). Use supplied ¼-20x1" bolts to locate bottom of bracket, hand tighten nuts. Push bracket up onto the bottom of the glove box, mark out mounting hole centers. Remove bracket drill mounting holes in the bottom of the glove box with a 5/16" drill bit.

Please note: *Before drilling* any holes check area behind firewall/dash panels to make sure no damage or interference with equipment will occur by drilling holes and fitting of vents, hoses, wiring etc.

Using supplied heater hose hole template, position template in correct location on RH side of firewall/foot board area as shown on template and in Figure 3a. Mark out hole saw centers as stated on template, remove template. Carefully drill holes using supplied 1 ¼" hole saw as directed on template. Hole position may require trimming the side of the plastic shield so the hose will clear it as shown in Figure 3b. Install supplied grommets.

Ice Crusher Under Dash Cab Heater Can-Am Commander 1000 LTD

Using supplied LH side vent bracket, hold bracket up into position as shown in Figure 4a and 4b (use bare bracket with nothing attached). Mark out mounting hole centers. Remove bracket drill mounting holes in the lower dash (only the outer hole of bracket is used) and center cover with a ¼ " drill bit.

Remove center dash cover and using a roto or oscillating tool remove enough plastic from panel as shown in Figure 5 so the two duct hose can route over this panel. Be sure that the cut panel edges are not left jagged or sharp so as not to cut or damage the duct hose.

Using Figure 6 as a guide cut duct hoses to length (lengths measured with the duct hose in its compressed state, measure and cut accordingly) Make up hoses assemblies using supplied 2" Y connectors as shown in Figure 5. **Tip:** To attach duct hoses to Y's and/or Vents either twist Duct Hose or Vents in a "screw" action. Use cable ties around all duct hose connections.

Using supplied Push-Pins attach LH side vent bracket.

Using Figures 7a – 7f as a guide route all (Except vents and hoses on the heater bracket) the 2" duct hose from the vent positions to the heater mounting position Stretch hose as you route the hose to ensure you have enough hose to complete the installation. Pull 2" duct hoses through the drilled vent holes, attach the correct size vent to the duct hoses. Use cable ties around all duct hose connections. Clip Vents into position.

Using supplied terminals and wire make up switch wiring extension loom with the female terminals on one end and the male terminals on the other. Remove wiring from switch noting correct wire position. Connect wiring from loom to the heater.

Using supplied terminals and wire make up power loom. Connect loom to the heater power connector.

Using supplied heater hose pass each end through the grommets in the firewall from the **radiator side** of the firewall approximately 12"; do not cut hose to do this. **Tip:** Using dish soap or a rubber/plastic cleaner on the hose will make the hose slip through the grommets easier. This can also be used on any hoses fittings and Y connectors to make connecting into hoses easier.

Using the supplied heater face plate fit into heater as shown in Figure 9. Attach the three 50mm connectors to face plate using six supplied #8 x ½" screws as shown in Figure 8.

Install heater mounting brackets to heater as shown in Figure 9 using supplied 5/16"x5" bolts.

Fit vent to mounting brackets and attach duct hoses. Use cable ties around all duct hose connections.

Route the 2" duct hose from the vent positions to the heater mounting position stretch hose as you route the hose to ensure you have enough hose to complete the installation. Pull 2" duct hoses

Ice Crusher Under Dash Cab Heater Can-Am Commander 1000 LTD

through the vent holes, attach the correct size vent to the duct hoses. Use cable ties around all duct hose connections. Clip Vents into position.

Move heater into position. Attach heater hoses to heater unit pushing the hose completely onto the heater fittings, secure with supplied #10 hose clamps. **Please Note:** Be sure to remove factory shipping plugs from heater fittings if so fitted.

Attach duct hoses to the 50mm connectors on heater. Use cable ties around all duct hose connections.

Route wiring up the center dash area.

Fit heater into position as shown in Figure 2b pushing heater hoses back through the grommets. Use supplied $\frac{1}{4}$ -20x1" bolts to locate bottom of bracket, fit $\frac{1}{4}$ " fender washers and hand tighten nuts. Push bracket up onto the bottom of the glove box. Use supplied $\frac{1}{4}$ -20x3/4" bolts, with $\frac{1}{4}$ " fender washers fitted and install from inside of glove box through the holes in the bottom of the glove box and through the heater mounting bracket, fit $\frac{1}{4}$ " nuts. Tighten all nuts. **Please Note:** This will require a little juggling to get the heater, heater and duct hoses into the correct position, and an assistant will be required to assist with the mounting bolts.

Locate Aux. positive power wire which is red in color Figure 11. Use quick connector to attach to the red heater power wire. Attach the black heater power wire to the main UTV chassis using the supplied $\frac{1}{4}$ -20x3/4" bolt and nut as shown in Figure 8b.

Route switch wiring extension loom to the LH side vent bracket. Connect the switch wiring extension loom to the switch using Figure 12 as a guide. Install switch, switch bezel, 7/16 washer and switch nut onto the vent bracket. Carefully align the locating tabs on the switch bezel with the small drilled holes. Tighten nut and fit knob.

Reconnect battery, turn key on to check fan operation. Use cable ties as necessary to secure looms.

Please Note: Before cutting any hose, be sure that the placement of the connectors will not interfere with any part of the UTV.

Locate the lower radiator hose at the front of the UTV, cut radiator hose as shown in Figure 13a removing approximately a 1" to 1.5" section of the hose. Insert the Y connector exactly in the radiator hose as shown in Figures 13b and 13c.

Remove engine covers, Locate the upper radiator hose as shown in Figure 14a (item 57) and 14b. Cut radiator hose as shown in Figure 14b removing approximately a 1" to 1.5" section of the hose. Insert the Y connector exactly in the radiator hose as shown in Figures 14b and 13c. Before cutting any hose,

Ice Crusher Under Dash Cab Heater Can-Am Commander 1000 LTD

be sure that the placement of the Y connector will not interfere with any part of the vehicle as the space is very limited in this area.

Please Note: Before connecting the hoses to the Y connectors, take a garden hose and run water through the heater hose and heater assembly. This will help remove air from the system and stop air locks, **this step must be carried out.**

Route one of the heater hoses over to Y connector in lower radiator hose. Cut heater hose to length. Route the remaining heater hose up to the Y connector at the engine. Cut heater hose to length.

Please Note: Make sure all hoses are as far away as possible from driveshaft, steering shaft, sharp objects and the exhaust system, etc. Use supplied cable ties as necessary to secure hoses.

Fit hoses to Y and T connectors and tighten clamps.

Locate a convenient position to install the shutoff valve in the heater hose connected to the engine.

Important: Refill cooling system as per manufacturer's procedure. Reconnect battery. Start and run the vehicle at a fast idle and run up to normal operating. Check for leaks. Check operation of heater.

Reassemble UTV as required.

Refill and bleed cooling system as per manufacturer's procedure. Start and run the vehicle at a fast idle and run up to normal operating temperature. Check for leaks. Check heater operation. Allow vehicle to cool and recheck cooling system level and coolant ratio, fill and/or alter coolant ratio as required.

If the heater fails to blow hot/warm air once the vehicle is up to operating temperature, there may be an air lock in the heater unit. Allow vehicle to cool, remove radiator cap, recheck cooling system level and coolant ratio, fill and/or alter coolant ratio as required. In the installation instructions it states "Please Note: Before connecting the hoses to the Y connectors, take a garden hose and run water through the heater hoses and heater assembly, make sure the shut off valve is fully open. This will help remove air from the system and stop air locks, this step must be carried out.". If this step was not carried out it must be done at this stage.

Start and run the vehicle at a fast idle and run up to normal operating temperature. If the heater still fails to blow hot/warm air, temporarily block off the top/inlet radiator hose at the radiator with an appropriate tool/clamp. Start and run vehicle up to operating temperature. Feel the outlet/lower hose from heater until it feels hot. The heater now should be blowing hot/warm air. Remove clamp from radiator hose. The heater should continue to blow hot/warm air. This procedure may have to be repeated a few times to remove air from system. Allow vehicle to cool, and recheck cooling system level and coolant ratio, fill and/or alter coolant ratio as required. Restart the vehicle and run up to

Ice Crusher Under Dash Cab Heater Can-Am Commander 1000 LTD

operating temperature, recheck heater operation. Please note: Heater output will be limited at idle, all testing should be done at a fast idle.

Ice Crusher Under Dash Cab Heater Can-Am Commander 1000 LTD

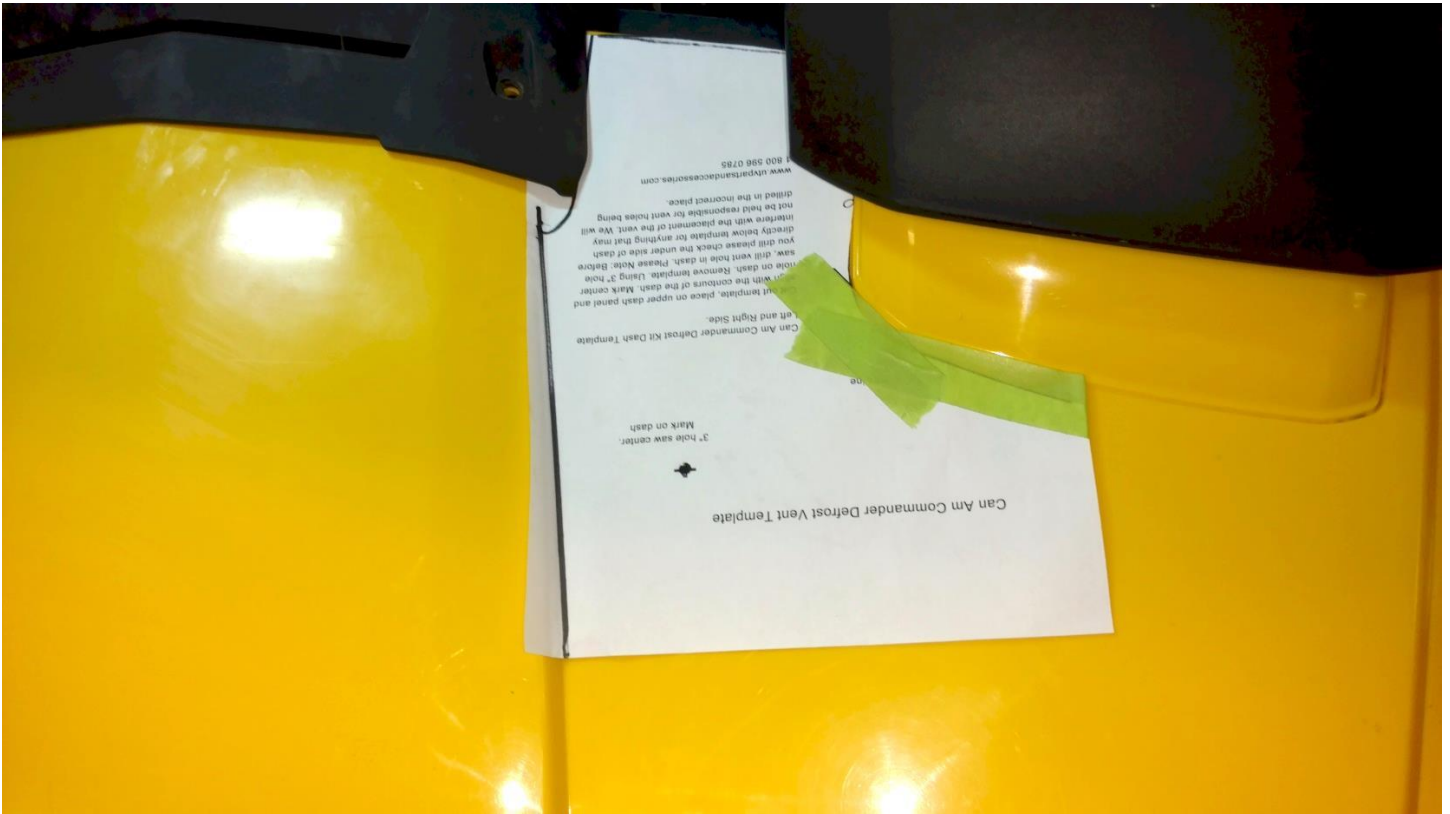

Figure 1



Figure 2a

Ice Crusher Under Dash Cab Heater Can-Am Commander 1000 LTD



Figure 2b



Figure 3a

Ice Crusher Under Dash Cab Heater Can-Am Commander 1000 LTD



Figure 3b



Figure 4a

Ice Crusher Under Dash Cab Heater Can-Am Commander 1000 LTD



Figure 4b

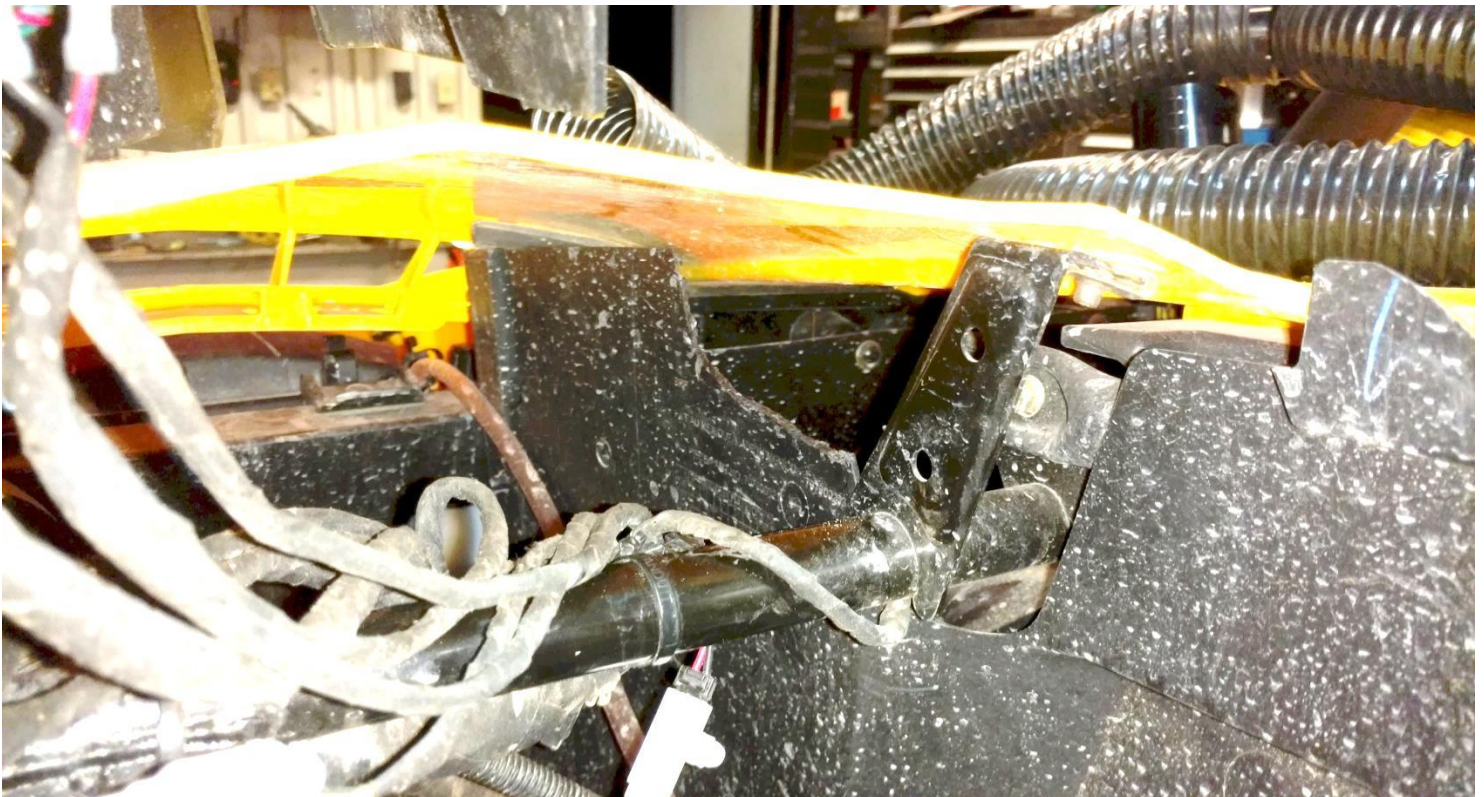
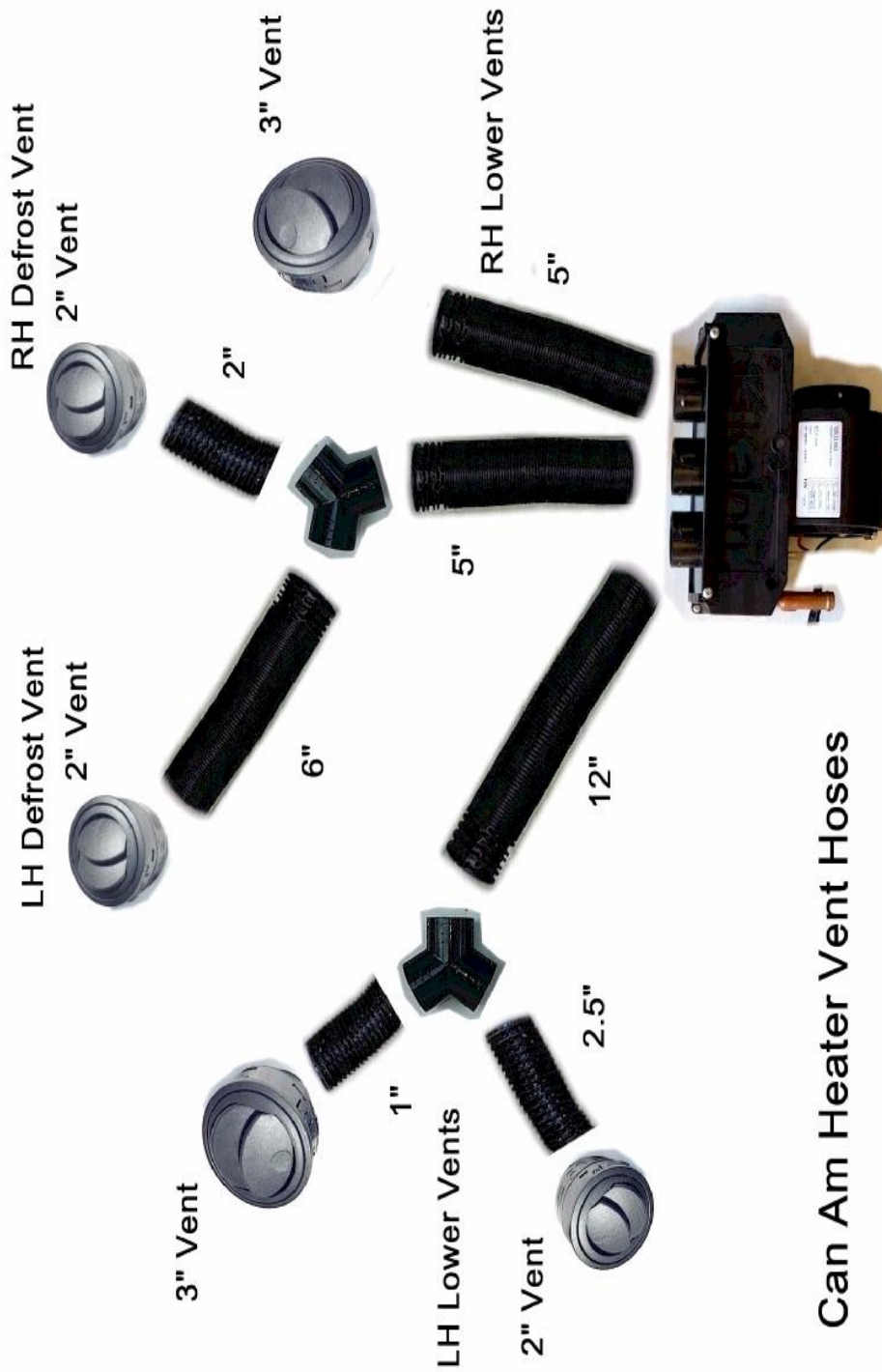

Figure 5

Ice Crusher Under Dash Cab Heater Can-Am Commander 1000 LTD



Can Am Heater Vent Hoses

Figure 6

Ice Crusher Under Dash Cab Heater Can-Am Commander 1000 LTD

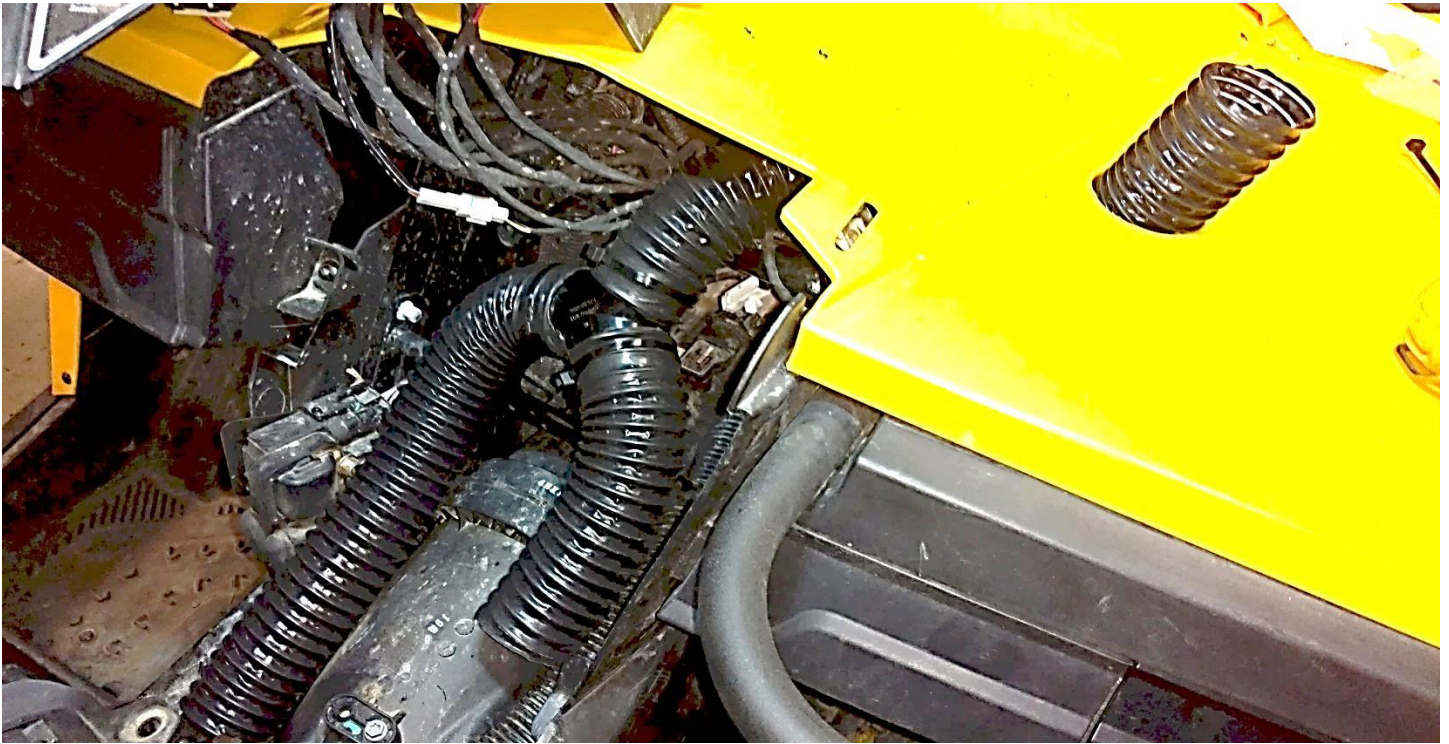

Figure 7a



Figure 7b

Ice Crusher Under Dash Cab Heater Can-Am Commander 1000 LTD

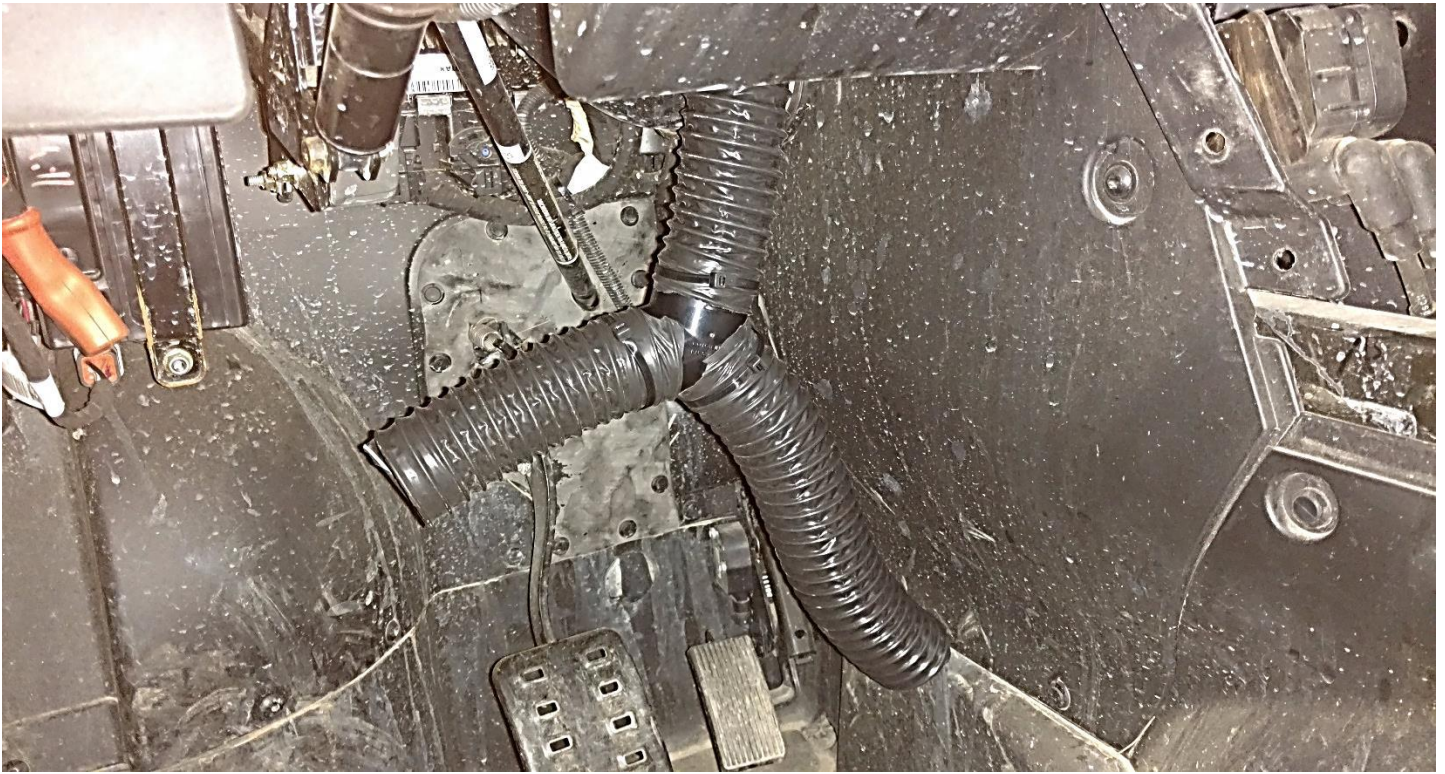

Figure 7c



Figure 7d

Ice Crusher Under Dash Cab Heater Can-Am Commander 1000 LTD



Figure 7e

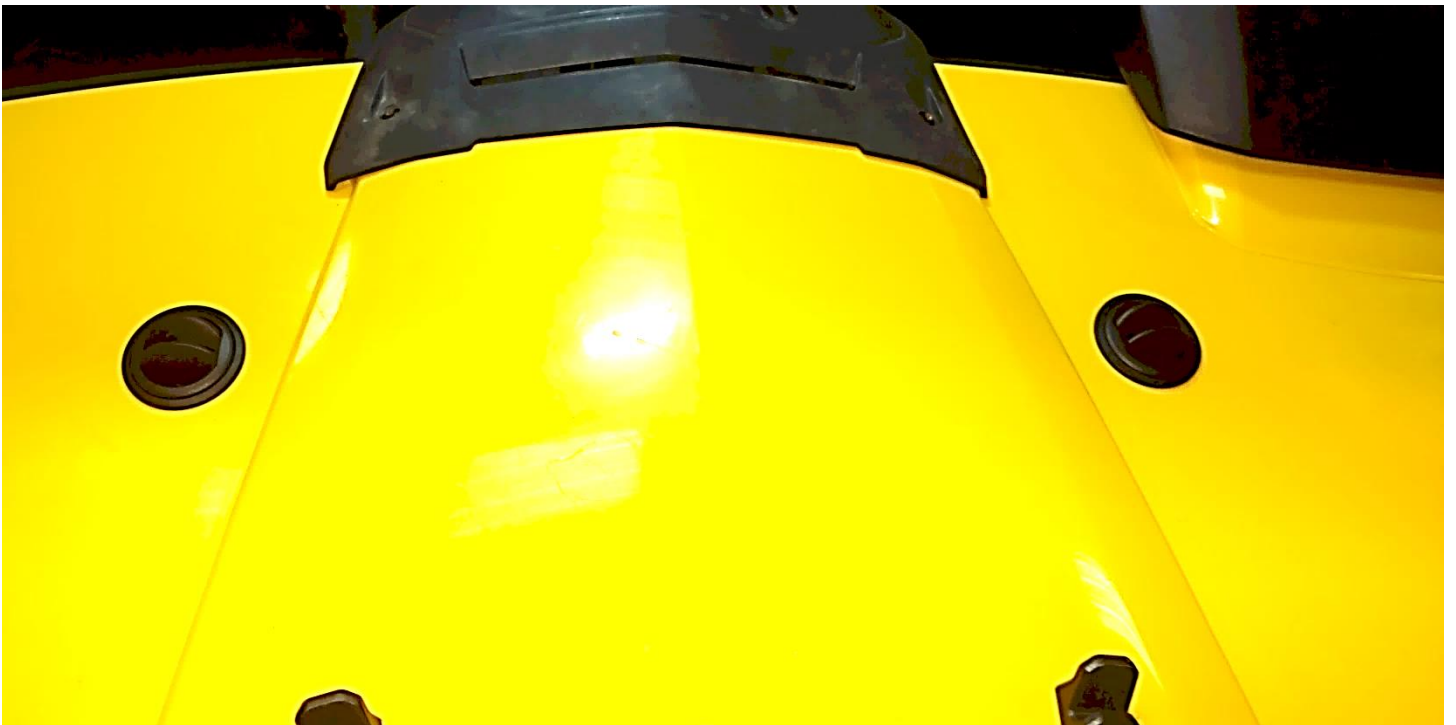

Figure 7f

Ice Crusher Under Dash Cab Heater Can-Am Commander 1000 LTD



Figure 8



Figure 9

Ice Crusher Under Dash Cab Heater Can-Am Commander 1000 LTD

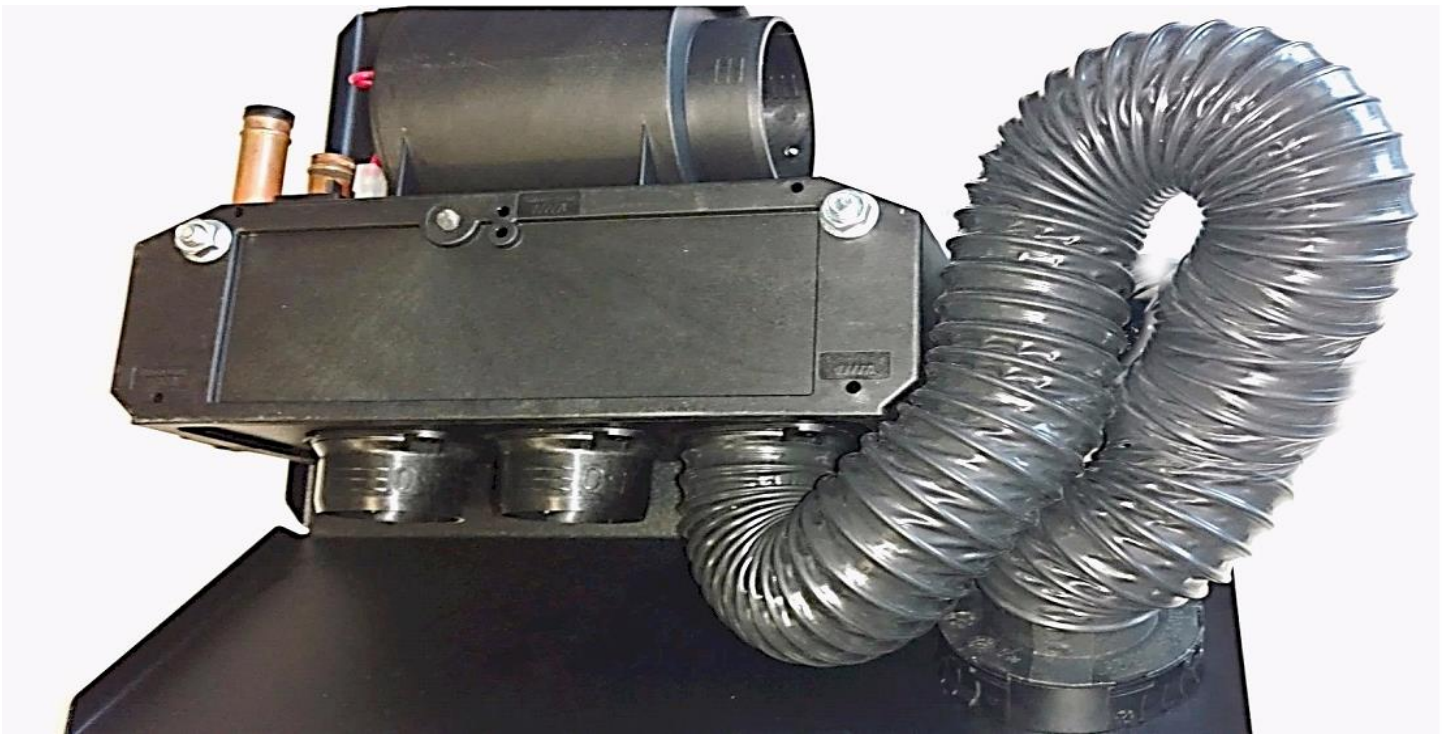

Figure 10

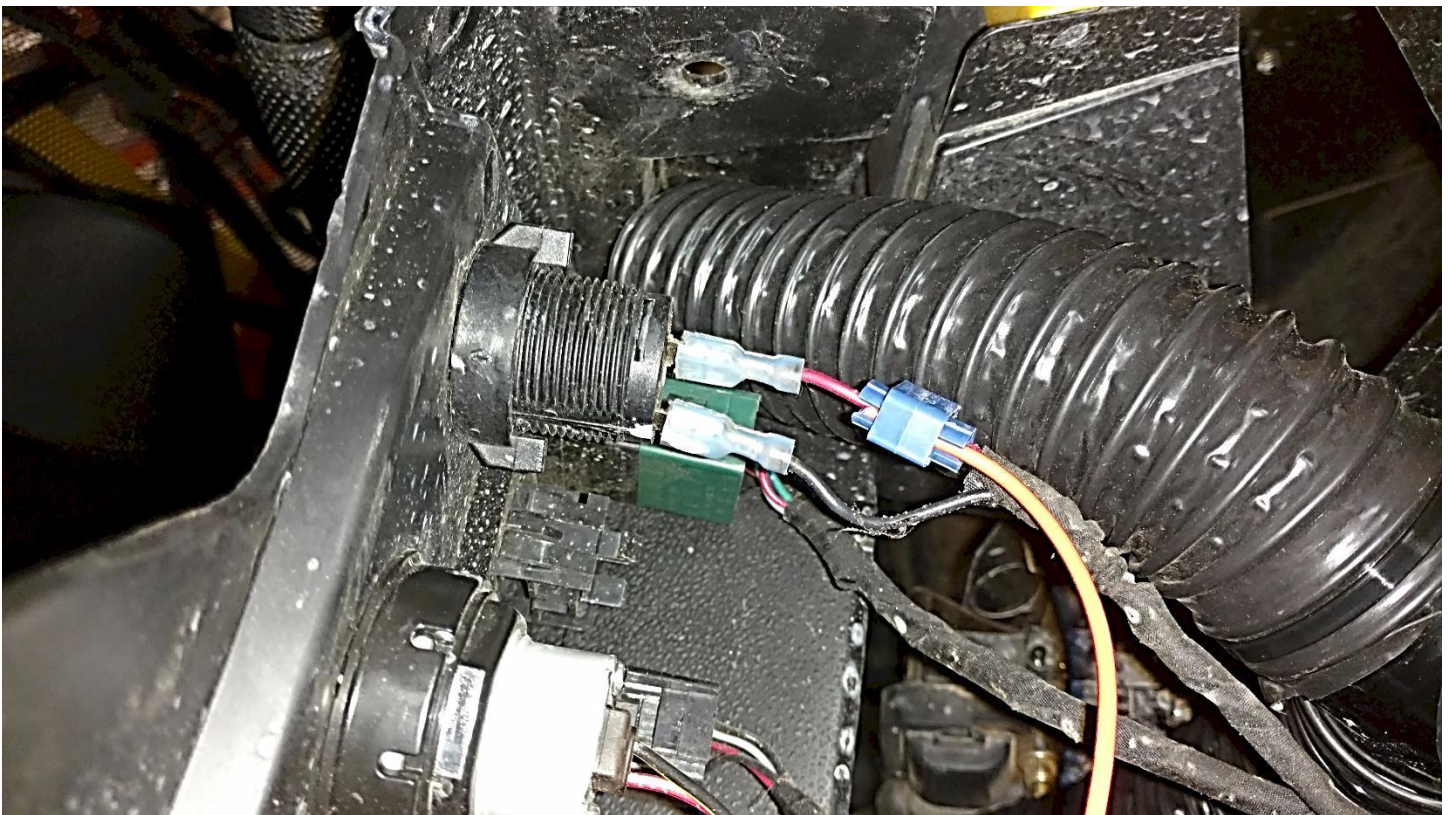

Figure 11

Ice Crusher Under Dash Cab Heater Can-Am Commander 1000 LTD

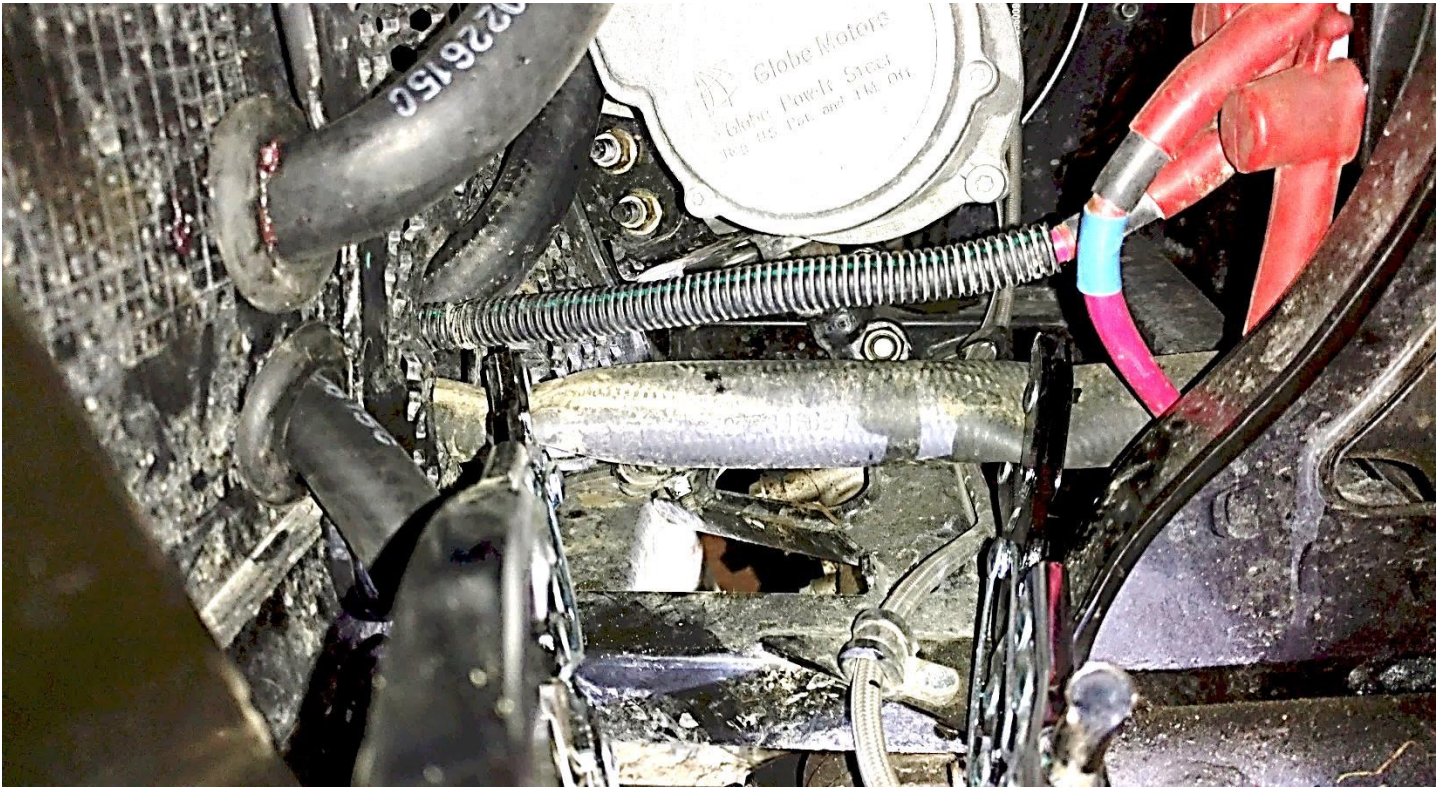

Figure 13a

Ice Crusher Under Dash Cab Heater Can-Am Commander 1000 LTD

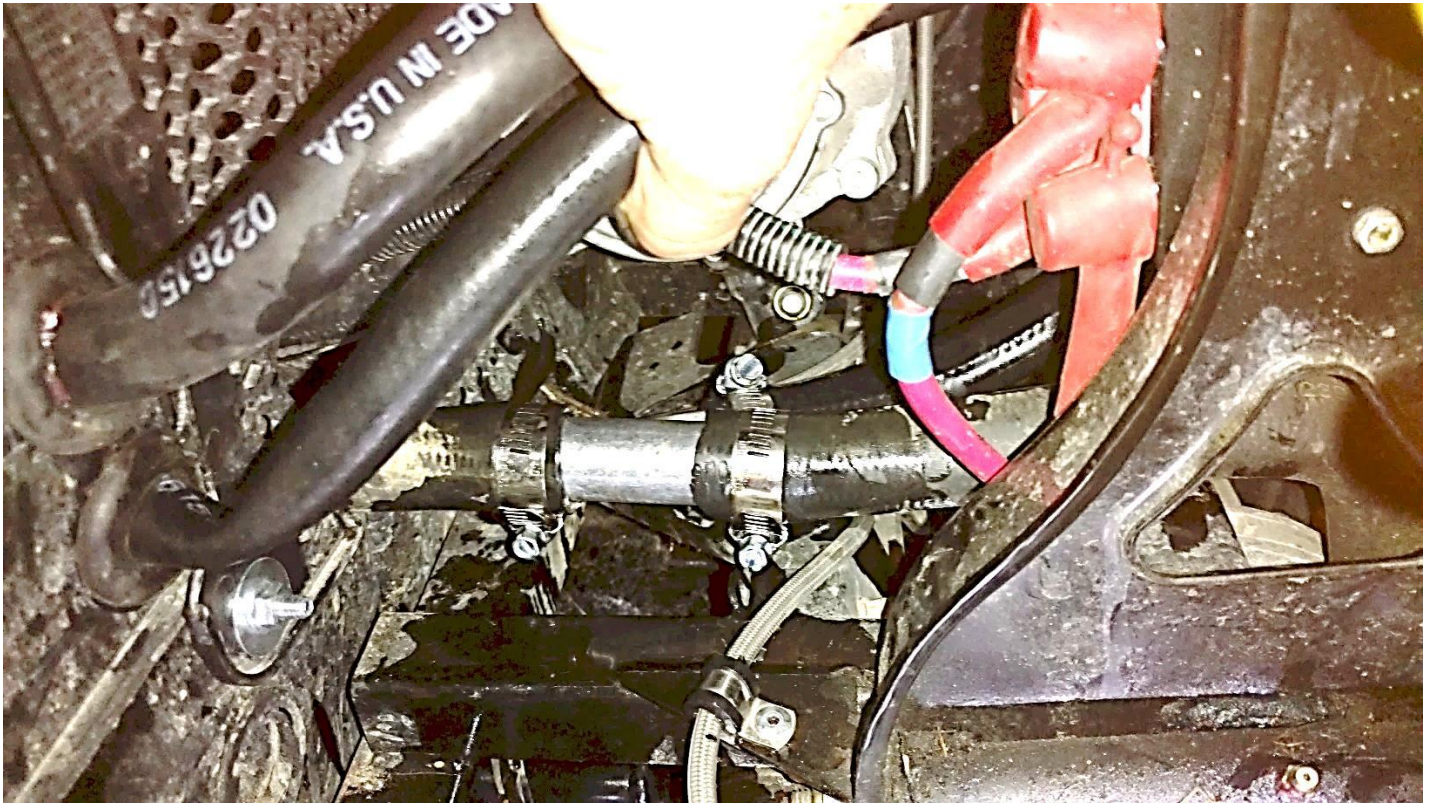

Figure 13b

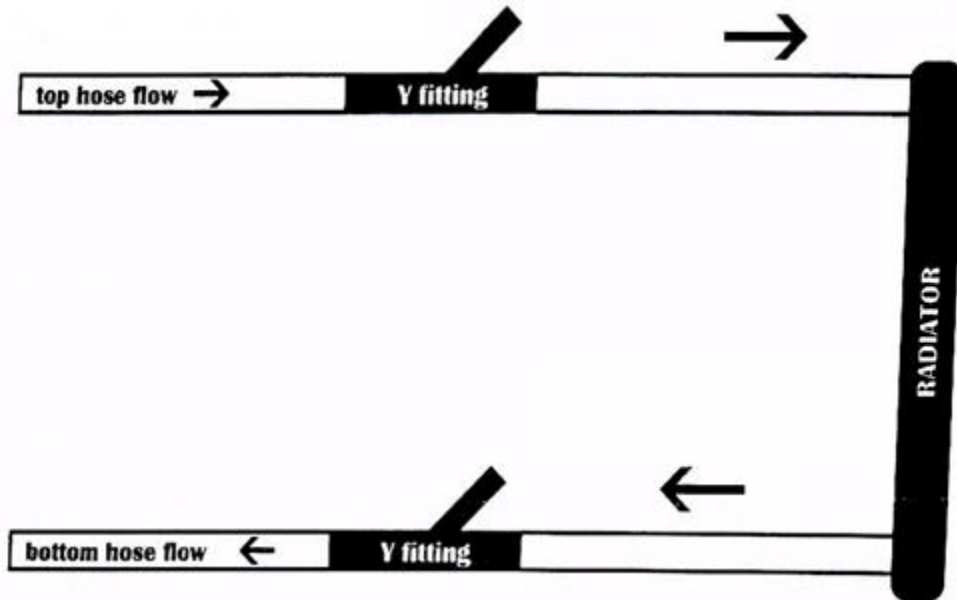

Figure 13c

Ice Crusher Under Dash Cab Heater Can-Am Commander 1000 LTD

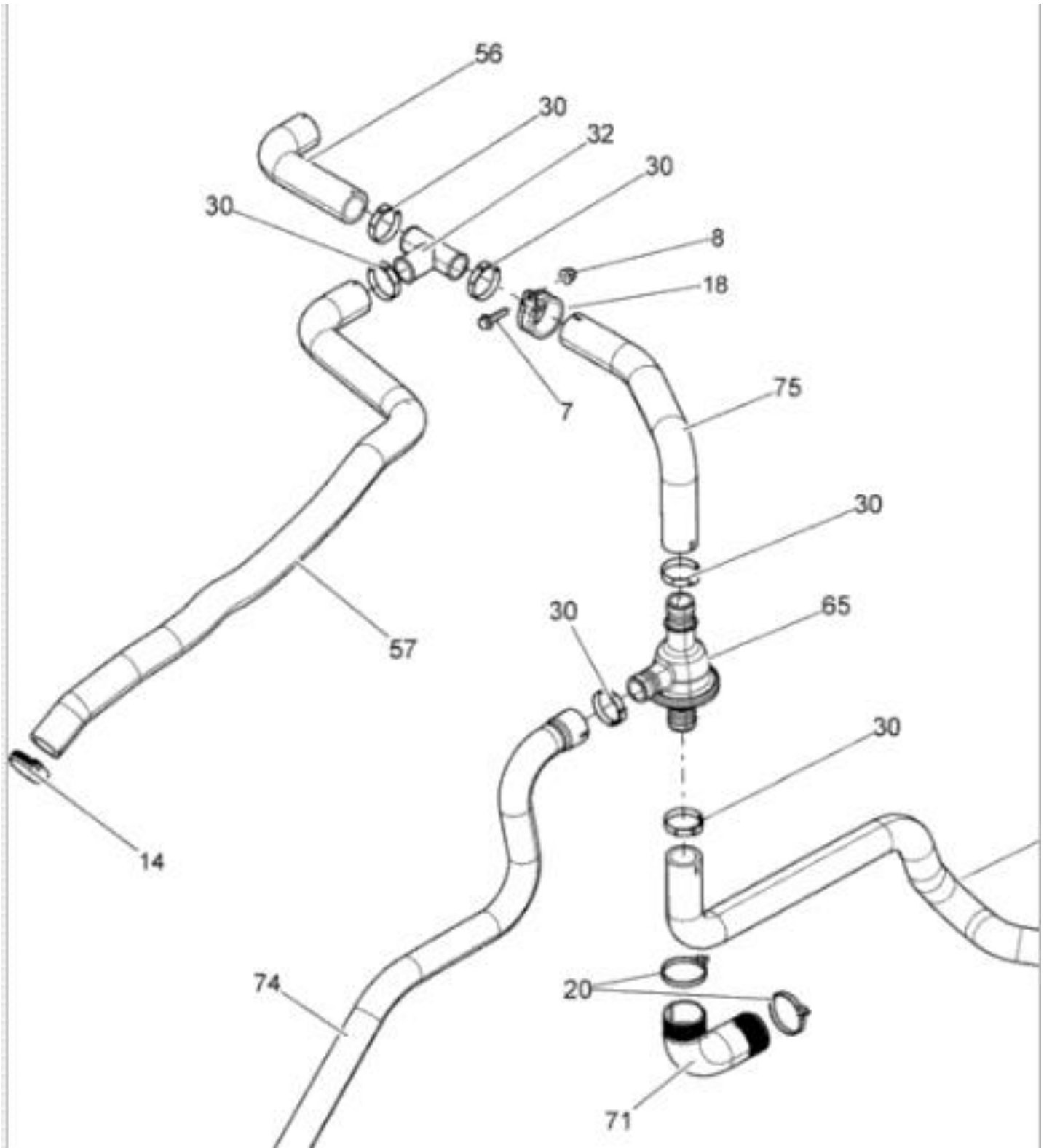

Figure 14a

Ice Crusher Under Dash Cab Heater Can-Am Commander 1000 LTD

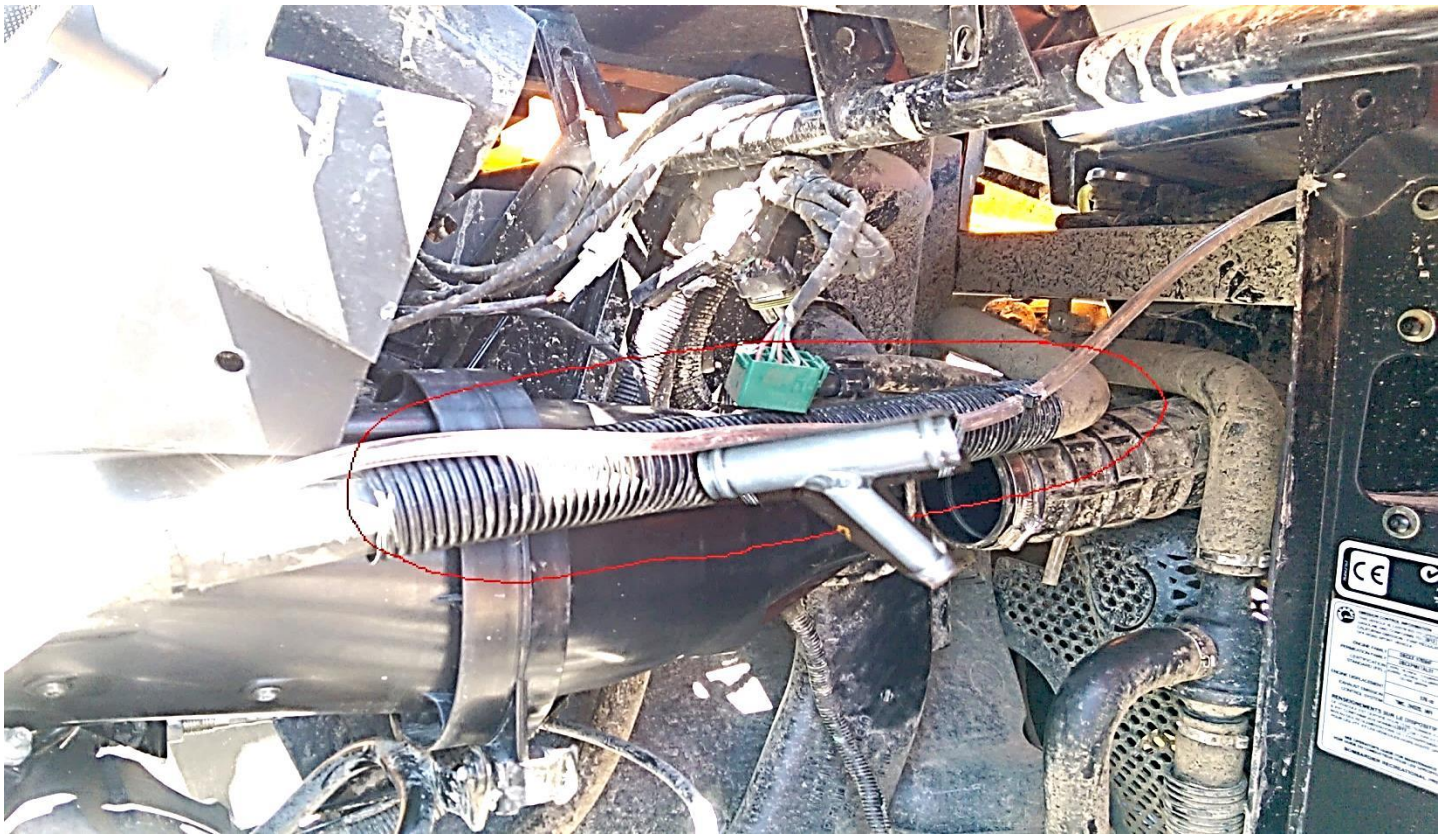

Figure 14b

Ice Crusher Under Dash Cab Heater Can-Am Commander 1000 LTD

HEATER WARRANTY – utvheaters.com and couperproducts.com

***Couper's Products/UTV Heaters.com Heater Warranty. 3 Year/36 Month Limited Warranty**

Couper's Products warrants your UTV Heater System to be free from defects in material and craftsmanship under normal use and service by the original consumer purchaser (end user) for a period of Three (3) year from the date of purchase on all components except electrical components including but not limited to, motor, switch, wiring and resistor. Electrical components are warranted to be free from defects in material and craftsmanship under normal use and service by the original consumer purchaser for a period of One (1) year from the date of purchase. The warranty is null and void if the system has been damaged by accident, improper installation, unreasonable use, lack of proper maintenance, unauthorized repairs or modifications, or causes not arising from defects in materials and craftsmanship.

Couper's Products obligation under this warranty are limited to repair of the product at Couper's Products production facility, or the replacement of the product at Couper's Products option and at Couper's Products expense. Any expense involved *in the removal, reinstallation, or transportation of the product is **not** covered by this warranty.* Prior to return of any product to Couper's Products customer must contact Couper's Products customer service, (802) 294 0016, and obtain a Return Authorization Number. This number must be marked on exterior of carton for easy identification. Warranty product received at Couper's Products without a Return Authorization Number may be returned at expense of sender.

Postage must be prepaid, and the original dated proof-of-purchase must be included. Couper's Products will not be liable for any damages sustained in transport due to improper packaging or handling. The acceptance by Couper's Products of any product returned shall not be deemed as an admission that the product is defective or in any violation of any warranty.

This warranty is Couper's Products only express warranty of this product. We reserve the right to make changes to products and policy that are in the best interest of Couper's Products. No implied warranty shall extend beyond One (1) or Three (3) year period from the date of the original consumer (end user) purchase. Couper's Products will not be liable for any damages, for loss of use of this product, nor for any consequential damages, costs or expenses.

Some states do not allow limitations on how long an implied warranty lasts or the exclusion of incidental or consequential damages, so the above limitations and exclusions may not apply to you. This warranty gives you specific legal rights and you may also have other rights not mentioned here that vary from state to state.

After receiving a Return Authorization Number send defective product to:

**Ice Crusher Heaters
23001 Industrial Blvd
Rogers, MN, 55374
888-964-0135**

Can Am Commander Defrost Vent Template



55mm hole saw center.
Mark on dash

Cut Along Line

Can Am Commander Defrost Kit Dash Template
Left and Right Side.

Cut out template, place on upper dash panel and align with the contours of the dash. Mark center hole on dash. Remove template. Using 55mm hole saw, drill vent hole in dash. Please Note: Before you drill please check the under side of dash directly below template for anything that may interfere with the placement of the vent. We will not be held responsible for vent holes being drilled in the incorrect place.



CUT HERE

Can-Am Heater Hose Hole Template

Please note: Before drilling any holes check area behind firewall/dash panels to make sure no damage or interference with equipment will occur by drilling holes and fitting of vents.

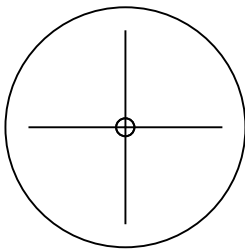
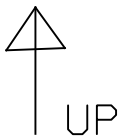

Mark hole center
and drill hole with
1 1/4 drill bit

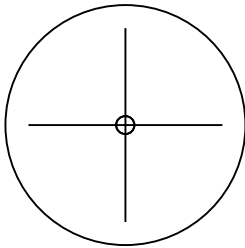

This is the last page.