



Made for first. Built to last.

DISCLAIMER:
PRODUCTS MADE BY L AND W FAB AND MACHINE INC. ARE INTENDED TO FIT YOUR STOCK UTV UNLESS OTHERWISE SPECIFIED. INSTALLING, MODIFYING, OR REMOVING ANY COMPONENTS (FACTORY OR AFTERMARKET) NOT SUPPORTED BY L AND W AND THE INSTRUCTIONS HEREIN WILL VOID YOUR WARRANTY. FOR MORE INFORMATION ON INSTALLATION, WARRANTY, OR PRODUCT USE PLEASE CALL US AT (770) 445-9778

PRO R/TURBO R WINCH MOUNT

Fitment: 2022 PRO R/TURBO R ALL TRIMS

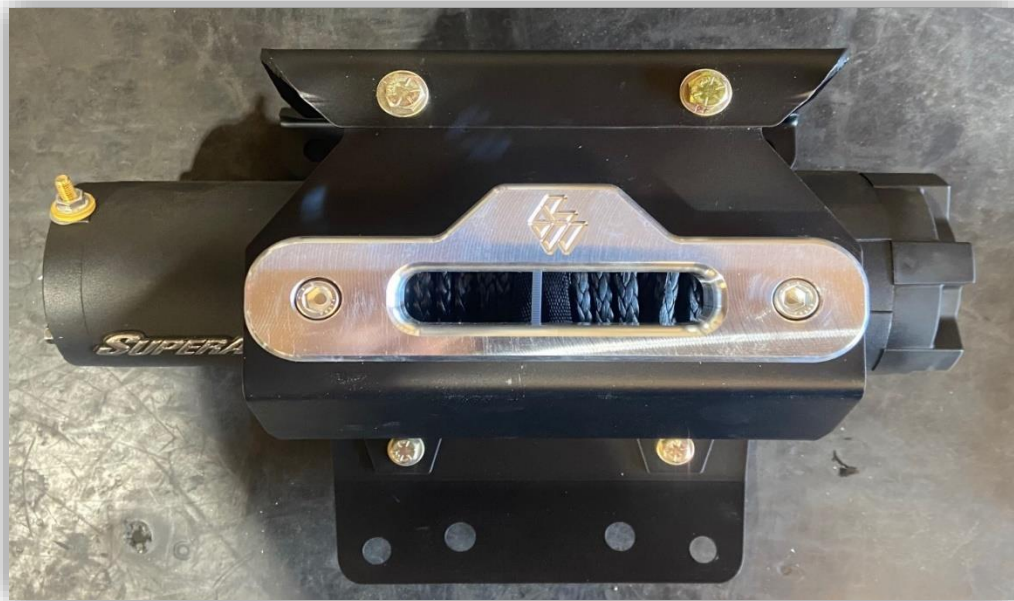

INSTALLATION MANUAL

Parts List:

Item #	Description	Qty.
1	WINCH PLATE	1
2	FAIRLEAD MOUNT	1
3	FASCIA	1
4	5/16X1 HEX BOLT	4
5	5/16 SAE WASHER	8
6	5/16 SPLIT LOCK WASHER	4
7	5/16 HEX NUT	4

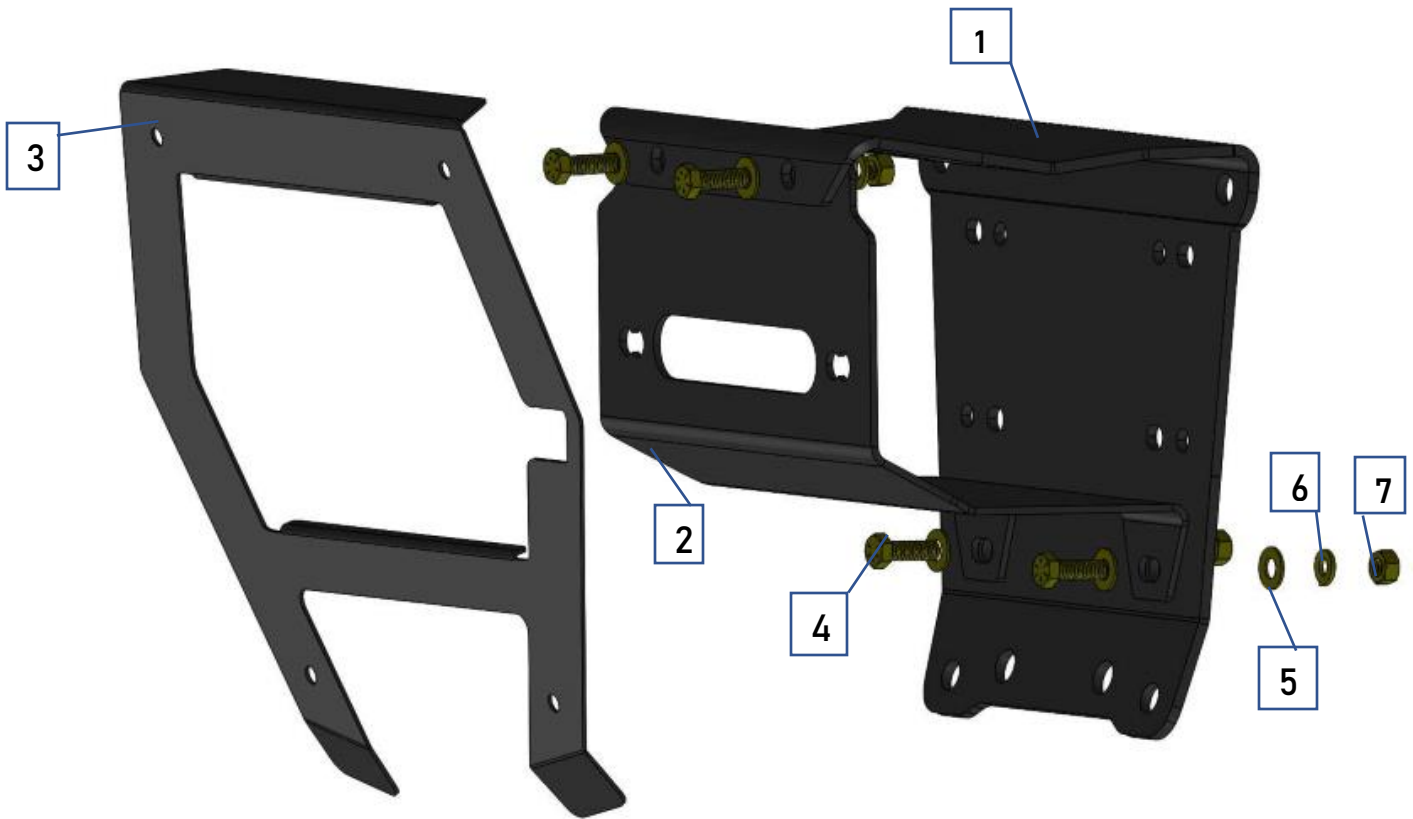

Installation:

STEP 1:

Layout parts as shown in the below picture to make sure all parts are present.



STEP 2:

Remove the (4) T40 Torx bolts from the front center fascia, and the (4) T40 Torx bolts holding the lower bumper cover and set to the side.

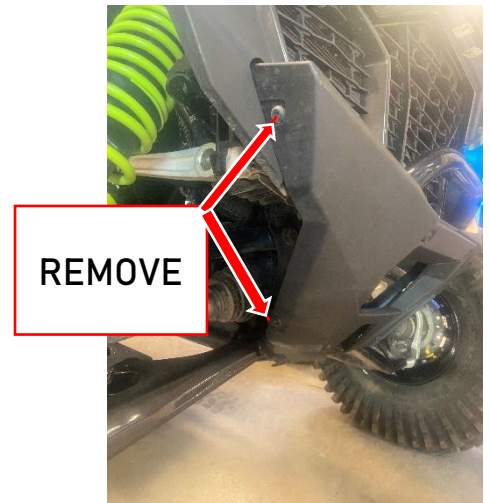

STEP 3:

With the front bumper cover removed, remove the (2) push pins holding the upper cover onto the factory bull bar.



STEP 4:

Remove the factory bull bar by removing the (4) bolts as shown. You will reuse the bolts on your new winch mount.

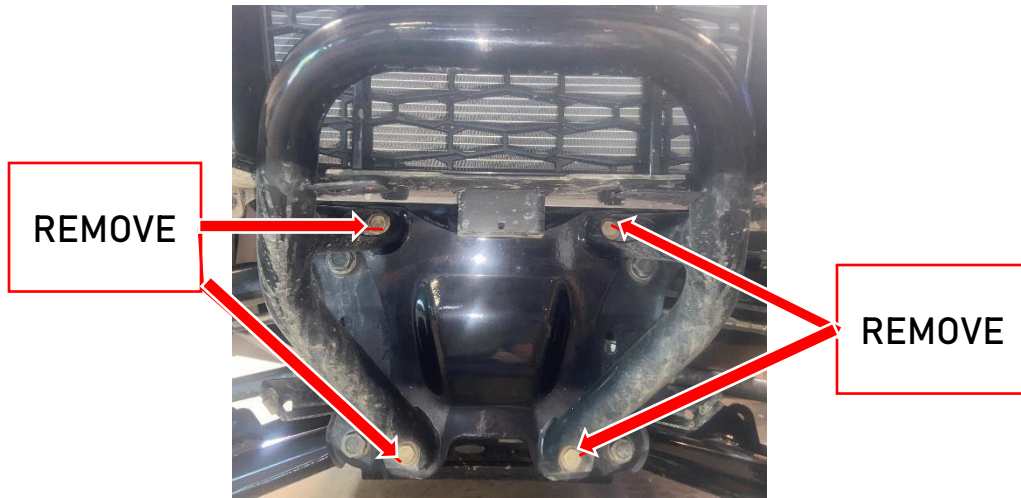

STEP 5:

Using the bolts supplied with your winch, bolt the winch to the winch plate and tighten as shown in the pictures. The motor leads should go on the passenger side.

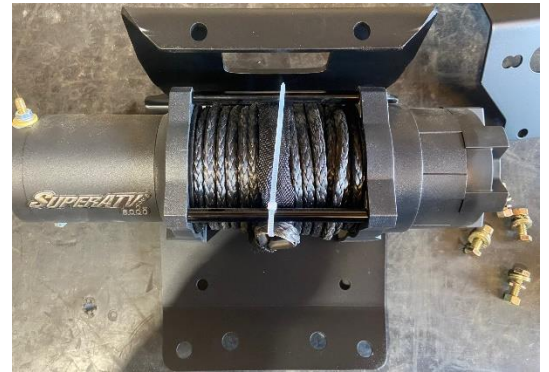

STEP 6:

Using the supplied bolts, washers, and nuts, bolt the fairlead mount to the winch plate as shown. The fairlead mount will go on the INSIDE of the winch mount.

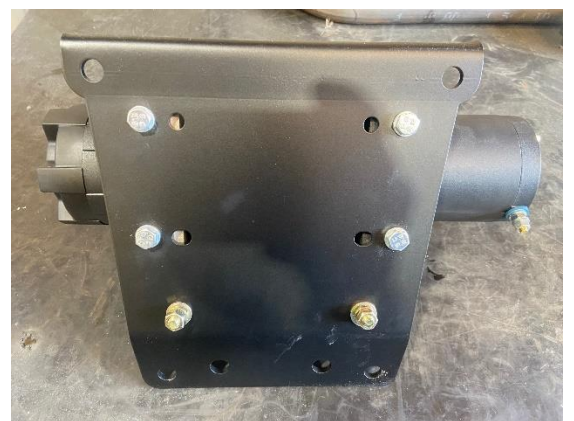
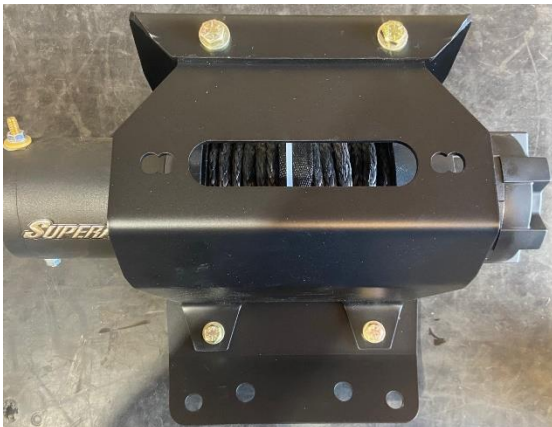

STEP 7:

Bolt your fairlead to the fairlead mount plate.

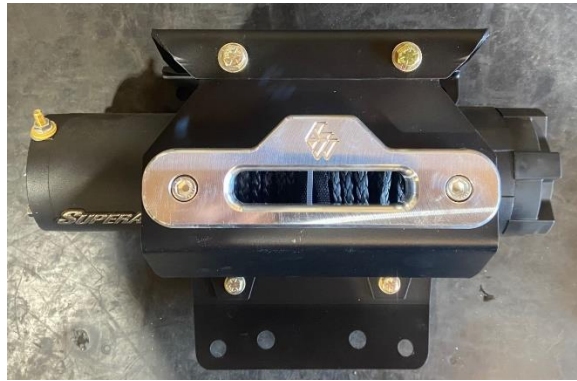

STEP 8:

Bolt the winch plate assembly onto machine using the (4) bolts removed from factory bull bumper bar. Once bolts are all started, torque to 60 ft/lbs.

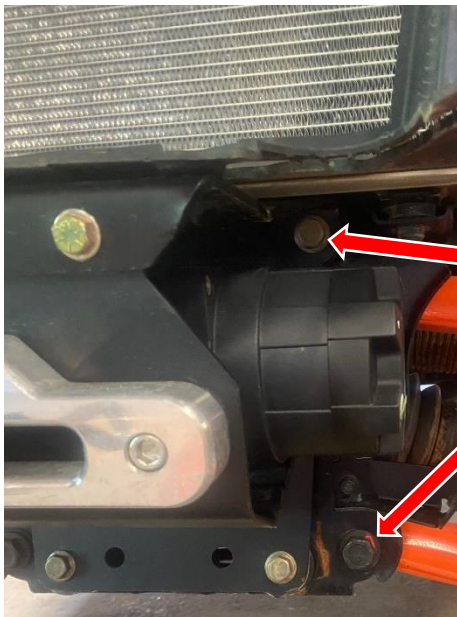

STEP 9:

Install the factory push pins through the plastic and into the new winch plate.



STEP 10:

Install the L&W fascia front cover on your factory plastic fascia using the bolts removed from factory cover. With the cover bolted together reinstall the front cover using the (4) factory bolts removed.



THANK YOU FOR CHOOSING L&W FAB!