

Installation Instructions

Eibach Springs, Inc. • 264 Mariah Circle • Corona, California 92879-1751 • USA • Tech Support 800-222-8811 Ext 114

PRO-UTV #E85-214-001-02-22

Kit Contents	Description	Part Number	Qty
	Front Main Spring	1600.300.0300S	2
	Front Secondary Spring	1000.300.0250S	2
	Rear Main Spring	1800.300.0200S	2
	Rear Secondary Spring	1400.300.0150S	2
	Slider	8001064	4
	Spring Adapter	234-00-491	2
	Rear Spring Retainer	234-00-420-1	2
	Instructions	PRO.UTVINST	1

NOTES: Read All Instructions Before Beginning Installation

- Only qualified technicians experienced in the installation and removal of suspension components should perform this installation.
- Use of a hoist and screw jack is highly recommended and will substantially reduce installation time.
- Never work on or under a vehicle unless it is properly supported.

RECOMMENDED FRONT SET-UP

1. Raise the front of the vehicle and support it with the proper safety equipment. **Note: Never work on or under a vehicle that is not supported by the proper safety equipment.**



Photo 1

2. Remove the front plastic cover. (See Photo 1)



Photo 2



Photo 3

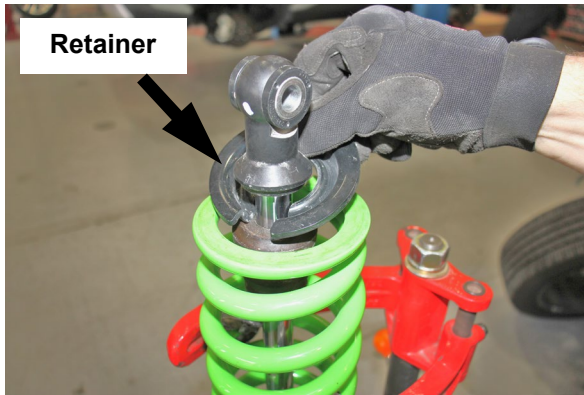

Photo 4

3. Loosen and remove the hardware that secures the coilover to the upper mount and lower control arm, then, remove the coilover as shown. (See Photos 2, 3 & 4)

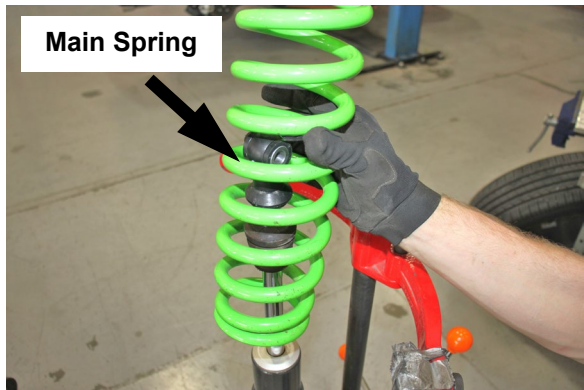

Photo 5



Retainer

Photo 6



Main Spring

Photo 7

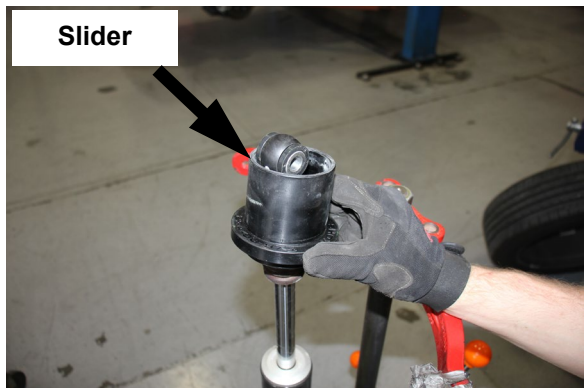

Slider

Photo 8

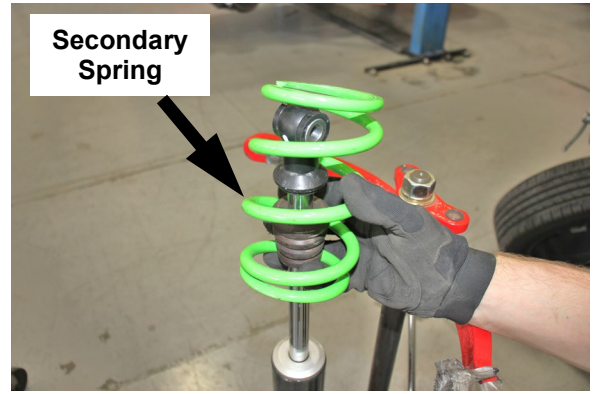

Secondary Spring

Photo 9

4. Use a spring compressor to remove the retainer, main spring, slider and the secondary spring as shown. (See Photos 5, 6, 7, 8 & 9)

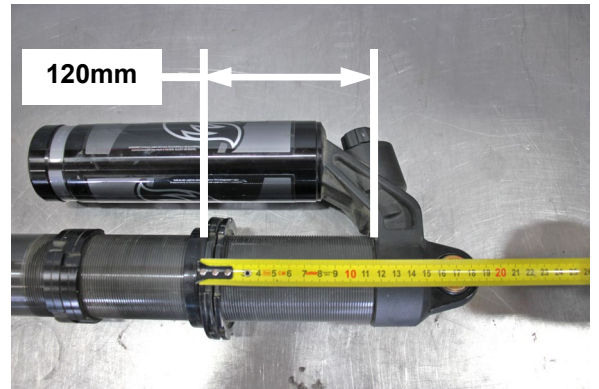

120mm

Photo 10

5. Adjust and set the preload collars to 120mm measuring from the bottom of the upper housing to the spring seat as shown. (See Photo 10)

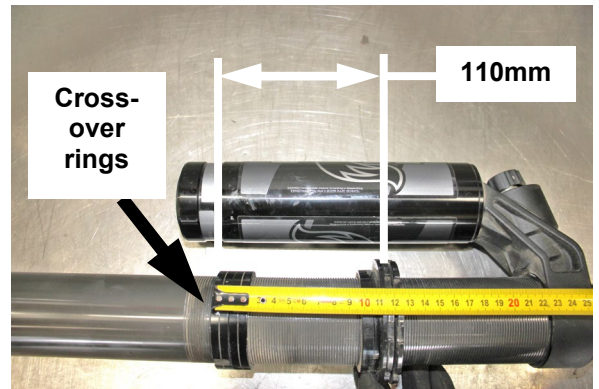

Cross-over rings

110mm

Photo 11

6. Install and set the OE crossover rings to 110mm as shown. (See Photo 11)

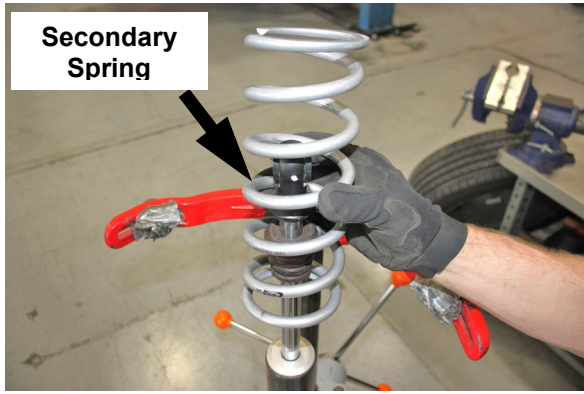

Photo 12

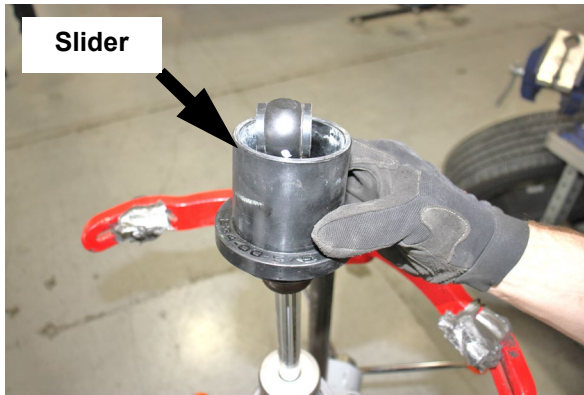

Photo 13

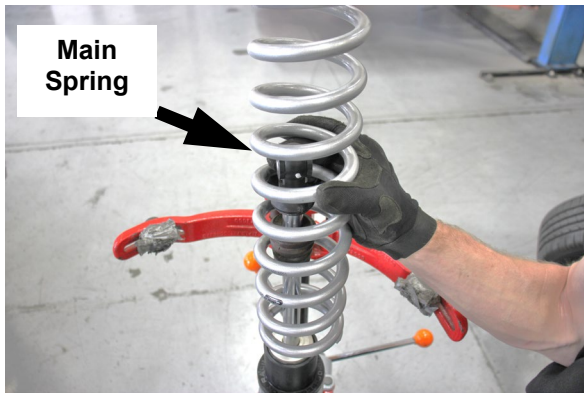

Photo 14

7. Install the secondary spring, provided slider, and main spring as shown. (See Photos 12, 13 & 14)

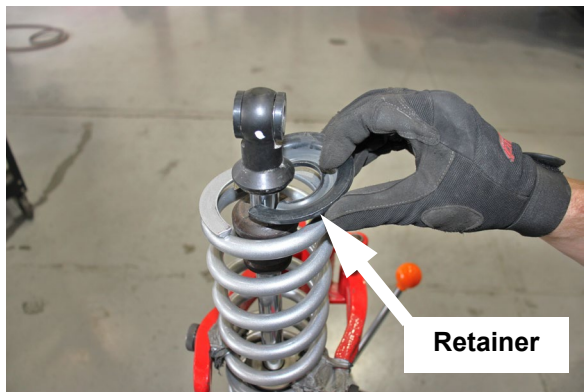

Photo 15



Photo 16

8. Compress the springs and install the OE retainer as shown. (See Photos 15 & 16)



Photo 17



Photo 18



Photo 19

9. You can now reinstall the coilover, and secure it using the OE hardware as shown. (See Photos 17, 18 & 19)
10. Repeat the process on the opposite side, then, reinstall the front wheels, set the vehicle on the ground, and roll it back and forth, making sure it's fully settled.

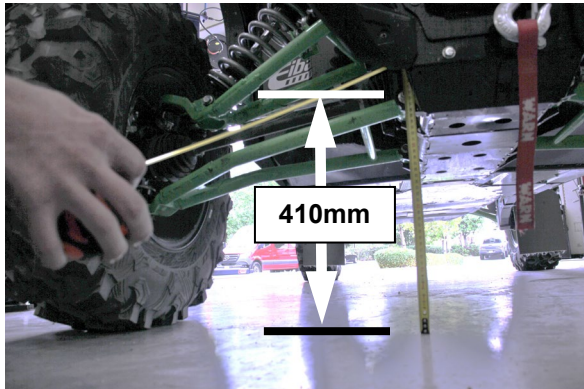

Photo 20

11. Adjust the preload collars to adjust the ride height. The recommended preload measurement in **step 5, photo 10**, will get the vehicle close to the recommended ride height, but each vehicle may vary some. We recommend setting the ride height to **410mm** from the ground to the center line of the inner control arm bolt as shown above. (See Photo 20) **Note: If running a larger overall wheel/tire combination, you may need to adjust the height accordingly.**

RECOMMENDED REAR SET-UP

1. Raise the rear of the vehicle until the wheels are off the ground and the suspension is fully unloaded. **Note: Never work on or under a vehicle that is not supported by the proper safety equipment.**



Photo 21



Photo 22



Photo 23

2. Loosen and remove the hardware that secures the coilover to the upper mount and lower control arm, then, remove the coilover as shown. (See Photos 21, 22 & 23)



Photo 24



Photo 25

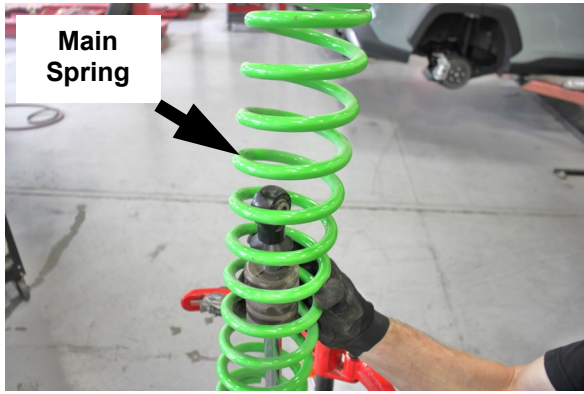

Photo 26



Photo 27

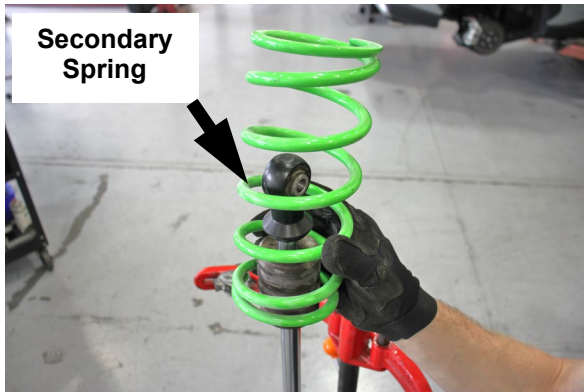

Photo 28

3. Use a spring compressor to remove the retainer, then, remove the main spring, slider, and secondary spring as shown. (See Photos 24, 25, 25, 27 & 28)



Photo 29



Photo 30

4. Remove the snap ring as shown. (See Photos 29 & 30)

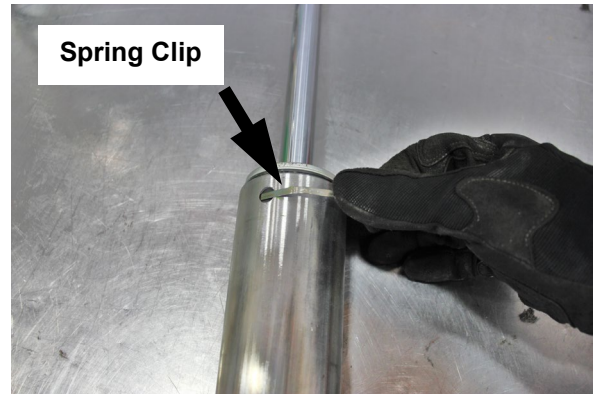

Photo 31

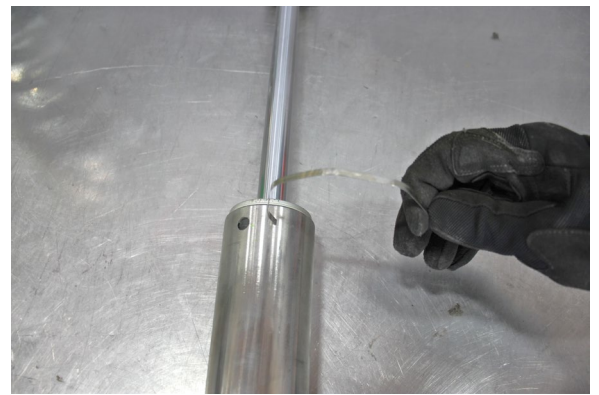

Photo 32

5. Remove the spring clip as shown. (See Photos 31 & 32)

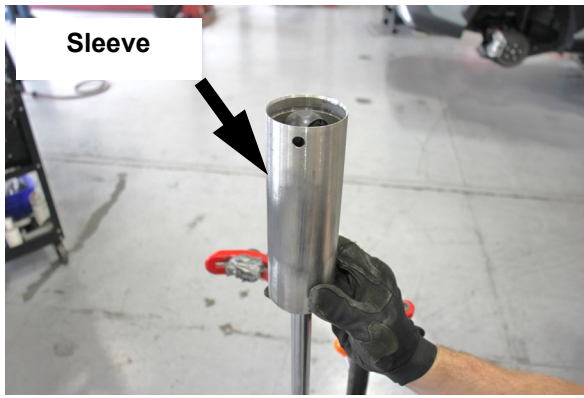

Photo 33

6. Remove the sleeve. (See Photo 33)



Photo 34

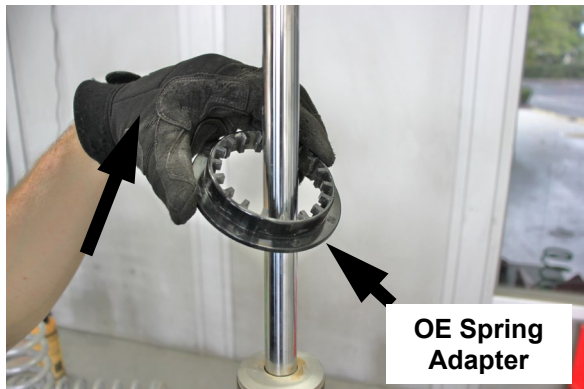

Photo 35

7. Remove the OE crossover rings, then, remove the OE spring adapter. (See Photos 34 & 35)



Photo 36

8. Install the provided spring adapter as shown. (See Photo 36)



Photo 37

9. Reinstall the OE crossover rings. (See Photo 37)

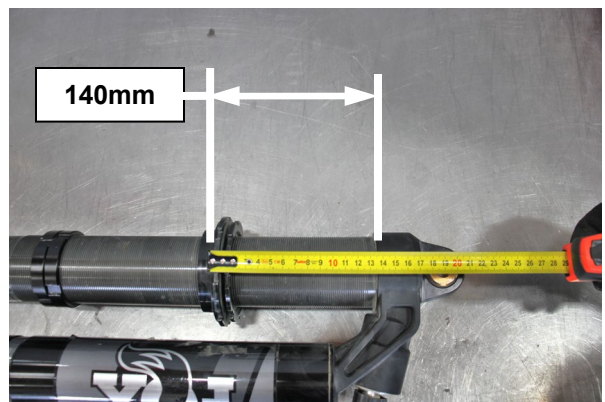

Photo 38

10. Adjust and set the preload collars to 140mm as shown. (See Photo 38)

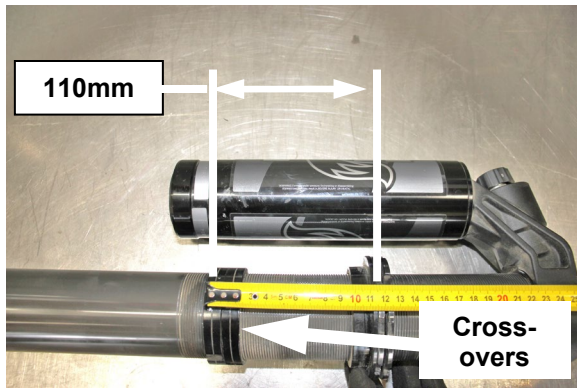

Photo 39

11. Set the crossover rings to 110mm as shown. (See Photo 39)

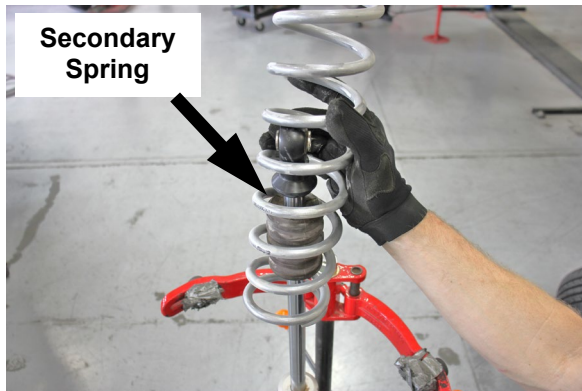

Photo 40



Photo 41

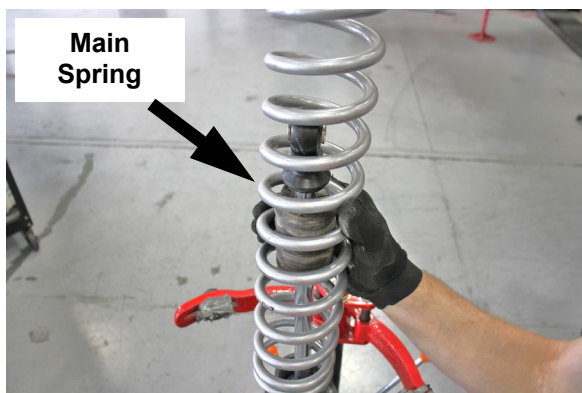

Photo 42

12. You can now install the secondary spring, provided slider, and main spring as shown. (See Photos 40, 41 & 42)



Photo 43



Photo 44

13. Compress the spring assembly, then install the provided spring retainer as shown. (See Photos 43 & 44)



Photo 45



Photo 46



Photo 47

14. You can now reinstall the coilover and secure it to the upper mount and lower control arm using the OE hardware as shown. (See Photos 45, 46 & 47)
15. Repeat this process on the opposite side, then, reinstall the rear wheels, set the vehicle on the ground and roll it back and forth, making sure the vehicle is fully settled.

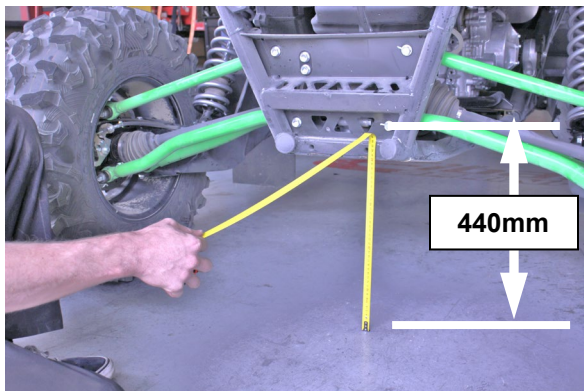

Photo 48

16. You can now adjust the preload collars to adjust the ride height. The recommended preload measurement in **step 10, photo 38**, will get the vehicle close to the recommended ride height, but each vehicle may vary some. We recommend setting the ride height to **440mm** from the ground to the center line of the lower control arm bolt as shown (See Photo 48)) **Note: If running a larger overall wheel/tire combination, you may need to adjust the height accordingly.**

RECOMMENDED FRONT AND REAR SHOCK SETTINGS

- **Compression Front:** 6 clicks out from full open.
- **Compression Rear:** Full Open

Note: These are the recommended shock settings that we tested using the spring rates provided in this kit