

# Installation Instructions

Eibach Springs, Inc. • 264 Mariah Circle • Corona, California 92879-1751 • USA • Tech Support 800-222-8811 Ext 114

## PRO-UTV #E85-211-003-02-22

**Note:** The UTV kit includes front and rear crossover rings. For this installation, the front crossover rings are set at full high, which will render them inactive. For more information about how to tune your front suspension with the crossover rings visit the following link. <http://eibach.com/america/en/motorsport/eibach-ero-eibach-racing-off-road-system-guide>

Kit Contents	Description	Part Number	Qty
	Front Main Spring	1200.300.0225S	2
	Front Secondary Spring	0600.300.0250S	2
	Rear Main Spring	1600.300.0200S	2
	Rear Secondary Spring	0800.300.0250S	2
	Crossover Ring	8001104	8
	Slider	8001064	4
	Adapter, Spring	234-00-491	2
	Retainer, Rear	234-00-420-1	2
	Instructions	PRO.UTVINST	1

### NOTES: Read All Instructions Before Beginning Installation

- Only qualified technicians experienced in the installation and removal of suspension components should perform this installation.
- Use of a hoist and screw jack is highly recommended and will substantially reduce installation time.
- Never work on or under a vehicle unless it is properly supported.

### RECOMMENDED FRONT SET-UP

1. Raise the front of the vehicle and support it with the proper safety equipment. **Note: Never work on or under a vehicle that is not supported by the proper safety equipment.**



Photo 1



Photo 2

2. Remove the screws that secure the upper cover, then, remove the cover as shown. (See Photos 1 & 2)



Photo 3

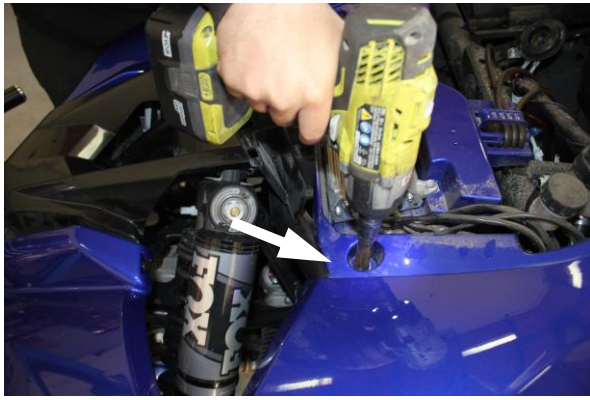

Photo 4



Photo 5

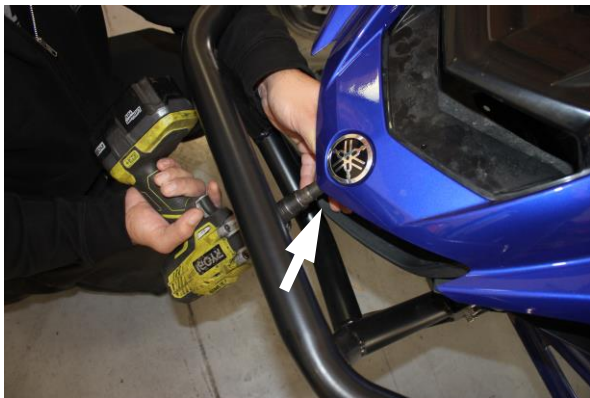

Photo 6



Photo 7



Photo 8



Photo 9

3. Loosen and remove the screws and miscellaneous plastic rivets that secure the forward cover, then, remove the cover as shown. (See Photos 3, 4, 5, 6, 7, 8 & 9)



Photo 10





Photo 11



Photo 12

4. Loosen and remove the hardware that secures the coilover to the upper mount and the control arm, then, remove the coilover as shown. (See Photos 10, 11, & 12)



Photo 13



Photo 14



Photo 15



Photo 16

5. Use a spring compressor to remove the retainer, main spring, slider, and secondary spring as shown. (See Photos 13, 14, 15 & 16)

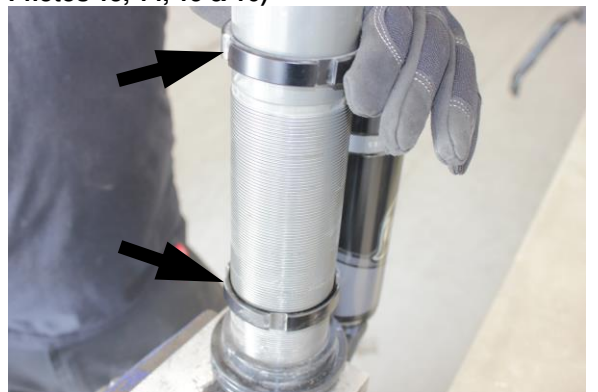

Photo 17

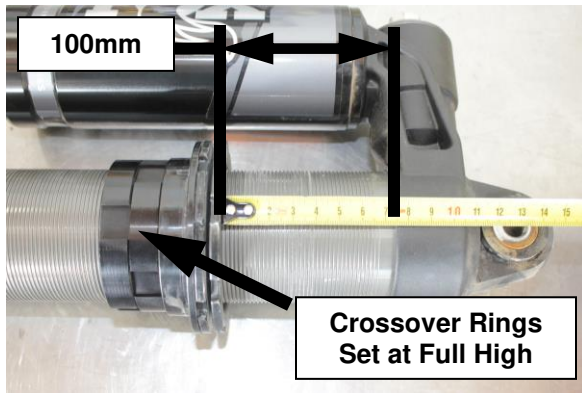

Photo 18

6. Install the provided crossover rings onto the coilover as shown, then, set the preload collars to **100mm** measuring from the housing to the top of the locking collar. **Note: Set the crossover rings at full high for this installation. (See Photos 17 & 18)**



Photo 19



Photo 20

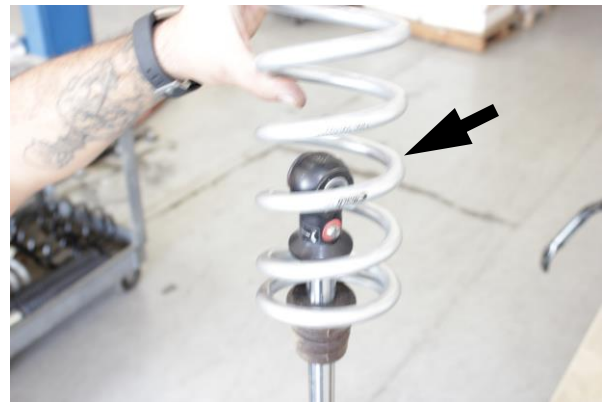

Photo 21

7. You can now install the secondary spring, provided slider, and main spring onto the coilover as shown. (See Photos 19, 20 & 21)



Photo 22

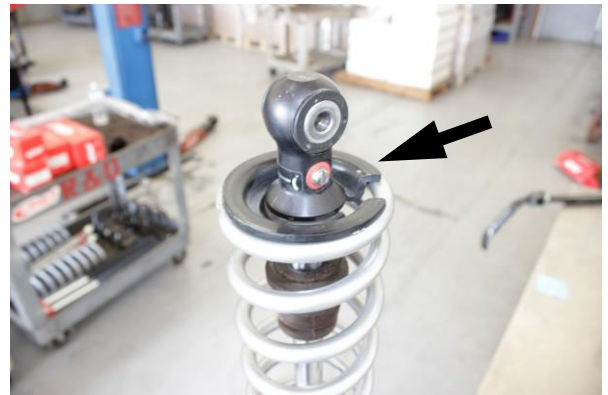

Photo 23

8. Reinstall the OE retainer as shown. (See Photos 22 & 23)





Photo 24



Photo 25



Photo 26

9. You can now reinstall the coilover using the OE hardware as shown. (See Photos 24, 25 & 26)
10. Repeat the process on the opposite side, then, reinstall the front wheels, set the vehicle on the ground, and roll it back and forth, making sure it's fully settled.

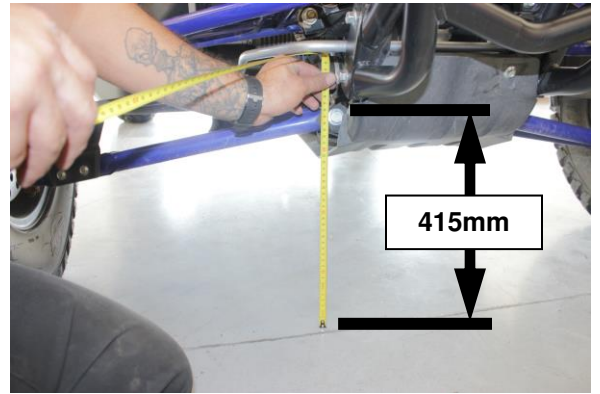

Photo 27

11. You can now adjust the upper spring perch to adjust the ride height. The recommended preload measurement in **step 6 photo 18** will get the vehicle close to the recommended ride height, but each vehicle may vary some. We recommend setting the ride height to **415mm** from the ground to the center line of the inner control arm bolt as shown above. (See Photo 27) **Note: If running a larger overall wheel/tire combination, you may need to adjust the height accordingly.**

### RECOMMENDED REAR SET-UP

1. Raise the rear of the vehicle until the wheels are off the ground and the suspension is fully unloaded. **Note: Never work on or under a vehicle that is not supported by the proper safety equipment.**



Photo 28

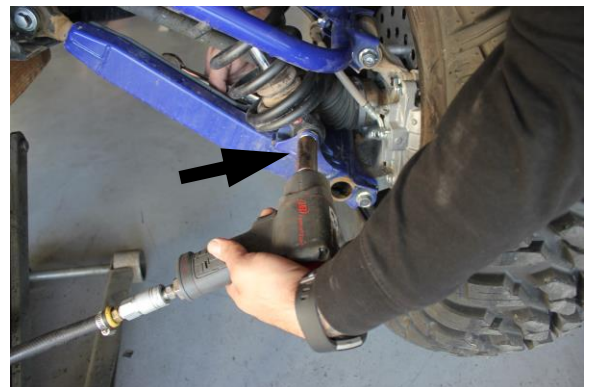

Photo 29



Photo 30

2. Loosen and remove the upper and lower coilover hardware, then, remove the coilover as shown. (See Photos 28, 29 & 30)



Photo 31



Photo 32



Photo 33



Photo 34

3. Use a spring compressor to remove the retainer, main spring, OE slider, and secondary spring as shown. **Note: The OE retainer will not be re-used.** (See Photos 31, 32, 33 & 34)



Photo 35

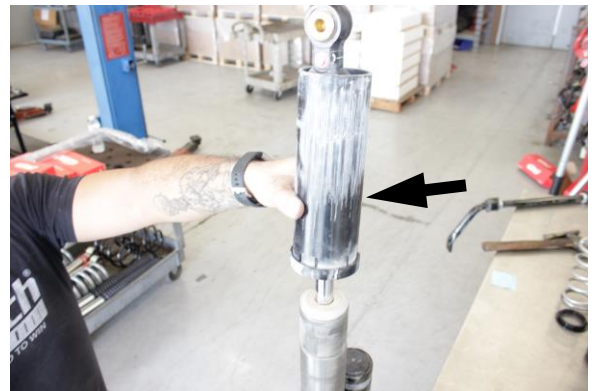

Photo 36

4. Remove the OE snap ring, then, remove the plastic sleeve as shown. (See Photos 35 & 36)





Photo 37



Photo 38

5. You can now remove the OE lockout ring and spring adapter from the coilover as shown. **Note: The OE crossovers and spring adapter will not be re-used for this installation. (See Photos 37 & 38)**

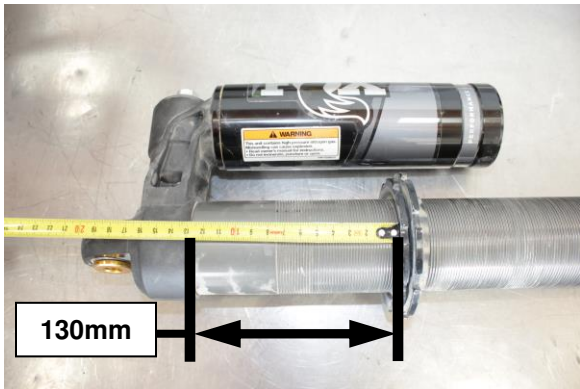

Photo 39

6. Adjust and set the preload collars to **130mm** measuring from the bottom of the housing to the top of the preload collars as shown. (See Photo 39)



Photo 40



Photo 41

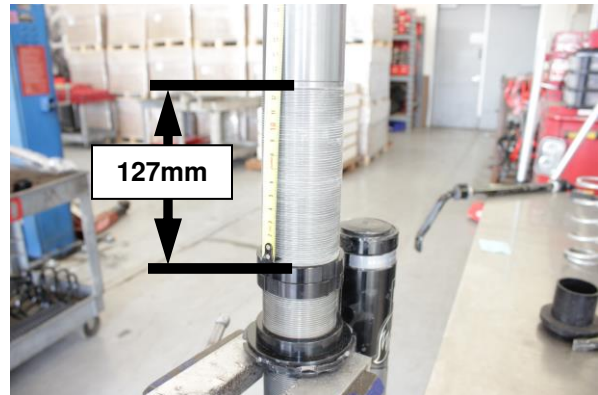

Photo 42

7. Install the new provided spring adapter and crossover rings and set them at **127mm** measuring from the end of the threads to the edge of the crossover rings as shown above. (See Photos 40, 41 & 42)



**Photo 43**

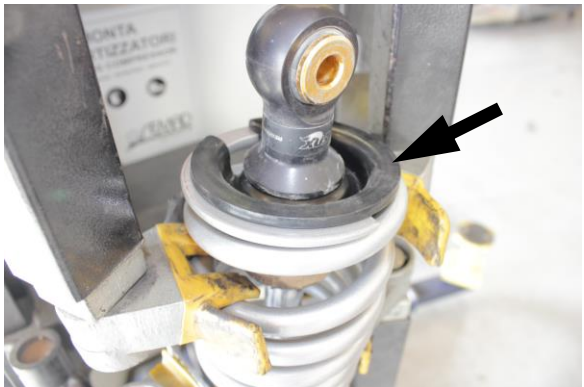

**Photo 44**



**Photo 45**

8. You can now install the secondary spring, provided slider, and the main spring as shown. (See Photos 43, 44 & 45)



**Photo 46**

9. Compress the spring assembly, then, install the provided spring retainer as shown. (See Photo 46)



**Photo 47**



**Photo 48**

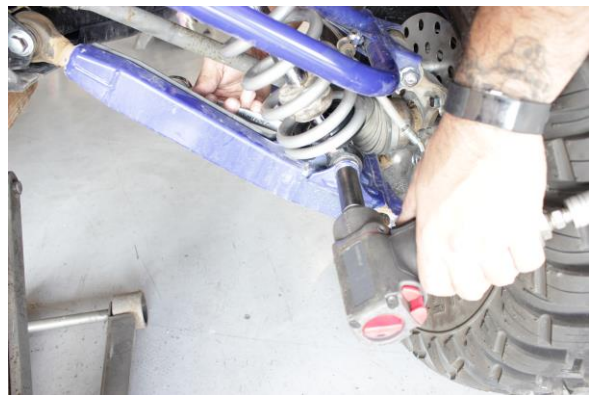

**Photo 49**

10. You can now install the coilover, securing it with the OE hardware. (See Photos 47, 48 & 49)
11. Repeat this process on the opposite side, then, reinstall the rear wheels, set the vehicle on the ground and roll it back and forth, making sure the vehicle is fully settled.



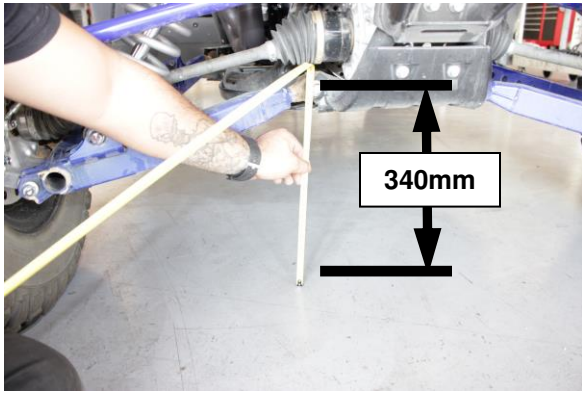

**Photo 50**

12. You can now adjust the upper spring perch to adjust the ride height. The recommended preload measurement in **step 6 photo 39** will get the vehicle close to the recommended ride height, but each vehicle may vary some. We recommend setting the ride height to **340mm** from the ground to the center line of the lower control arm bolt as shown. **(See Photo 50)** **Note: If running a larger overall wheel/tire combination, you may need to adjust the height accordingly.**

## RECOMMENDED FRONT AND REAR SHOCK SETTINGS

- **Front:**

Hi-Speed Comp: 2.5 turns out from closed  
Low-Speed Comp: 2 Turns out from closed  
Hi-Speed Rebound: 1.5 Turns out from closed  
Low-Speed Rebound: 2 turns out from closed

- **Rear:**

Hi-Speed Comp: 2.5 turns out from closed  
Low-Speed Comp: 2 Turns out from closed  
Hi-Speed Rebound: 1.5 Turns out from closed  
Low-Speed Rebound: 2 turns out from closed

**Note: These are the recommended shock settings that we tested using the spring rates provided in this kit**